

## PHG B167 SKF

Wrapped classical belt

TYPE: V- belts, Classical, Wrapped, Section 17/B (SKF)

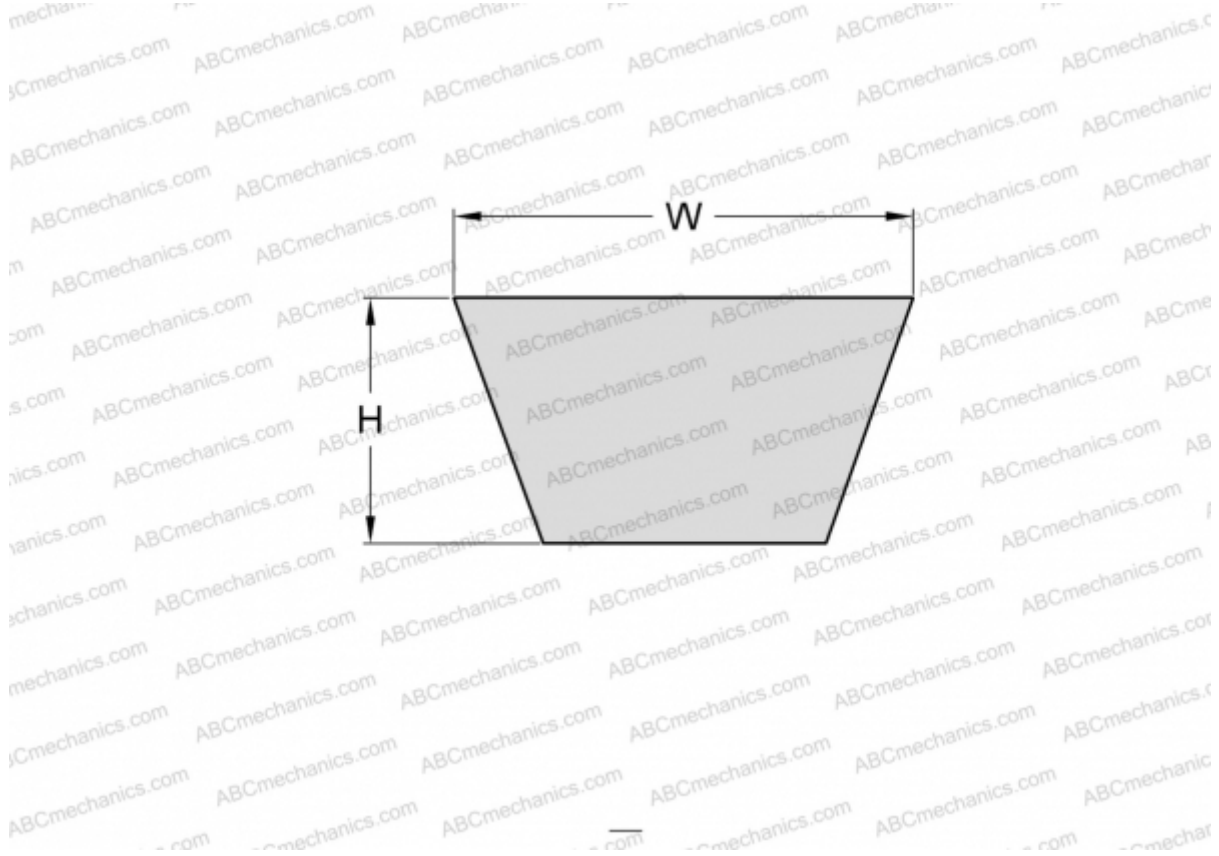

### Technical specification

#### DIMENSIONS, MM

Estimated length	4280,000
Inner length	4242,000
Width, W	17,000
Height, H	11,000

#### MANUFACTURER

[SKF](#)