

## PHG C53 SKF

Wrapped classical belt

TYPE: V- belts, Classical, Wrapped, Section 22/C (SKF)

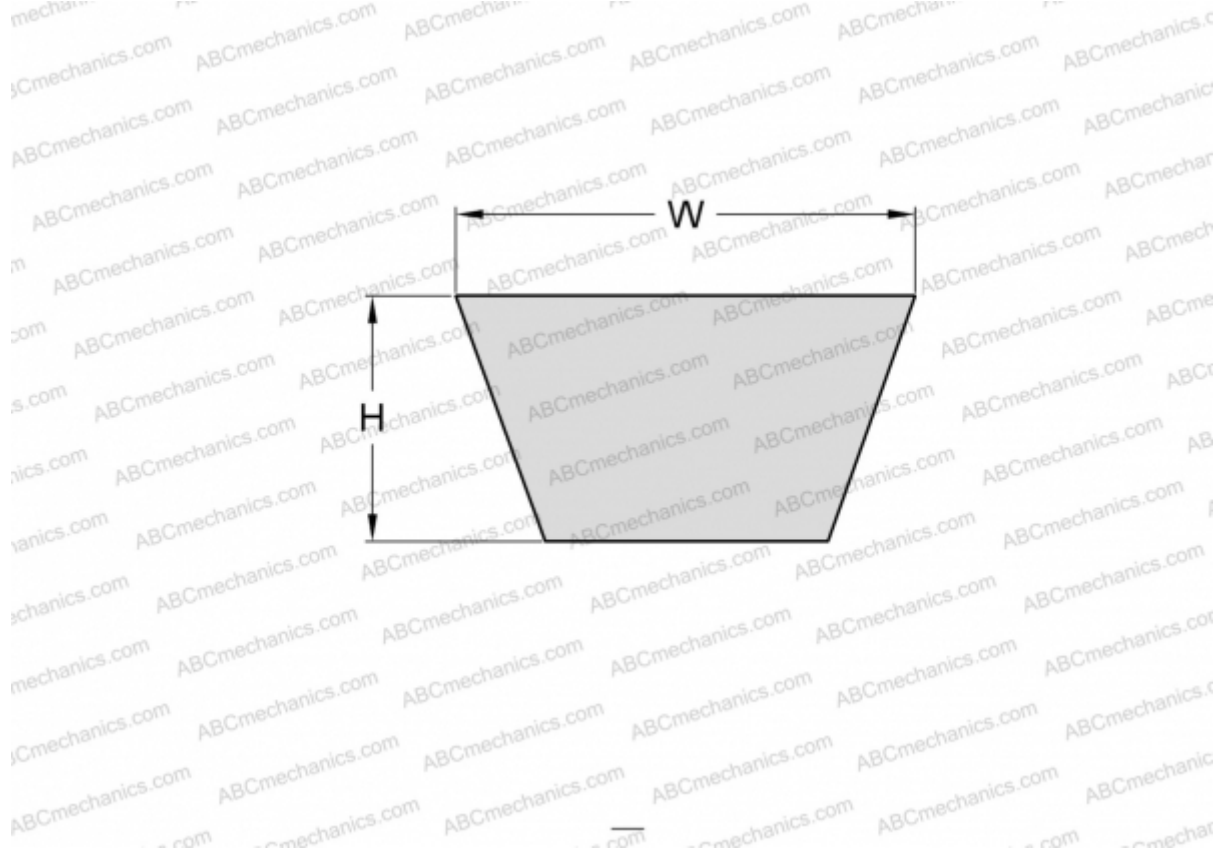

### Technical specification

#### DIMENSIONS, MM

Estimated length	1400,000
Inner length	1346,000
Width, W	14,000
Height, H	22,000

#### MANUFACTURER

[SKF](#)