

PHG C87 SKF

Wrapped classical belt

TYPE: V- belts, Classical, Wrapped, Section 22/C (SKF)

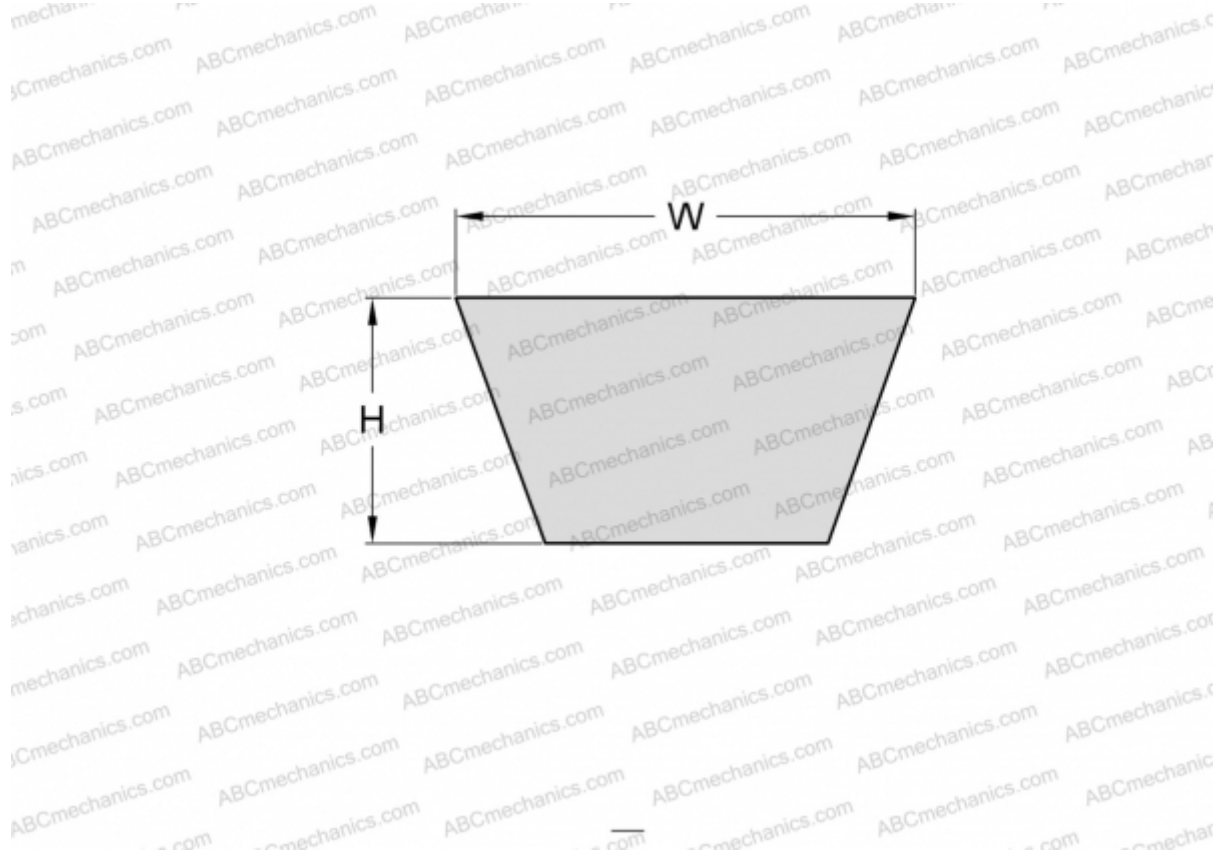

Technical specification

DIMENSIONS, MM

Estimated length	2270,000
Inner length	2210,000
Width, W	14,000
Height, H	22,000

MANUFACTURER

[SKF](#)