

PHG D173 SKF

Wrapped classical belt

TYPE: V- belts, Classical, Wrapped, Section 32/D (SKF)

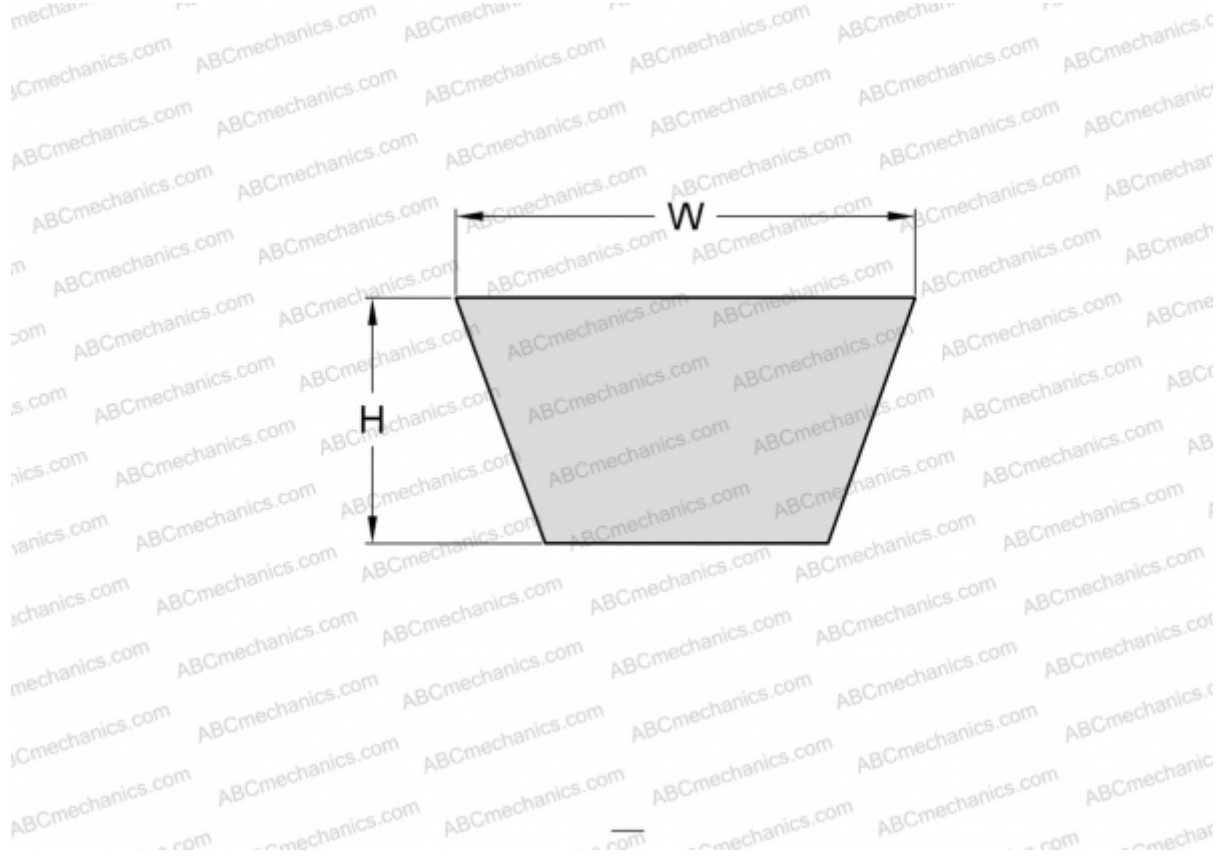

Technical specification

DIMENSIONS, MM

Estimated length	4470,000
Inner length	4394,000
Width, W	32,000
Height, H	20,000

MANUFACTURER

[SKF](#)