

## PHG E280 SKF

Wrapped classical belt

TYPE: V- belts, Classical, Wrapped, Section 38/E (SKF)

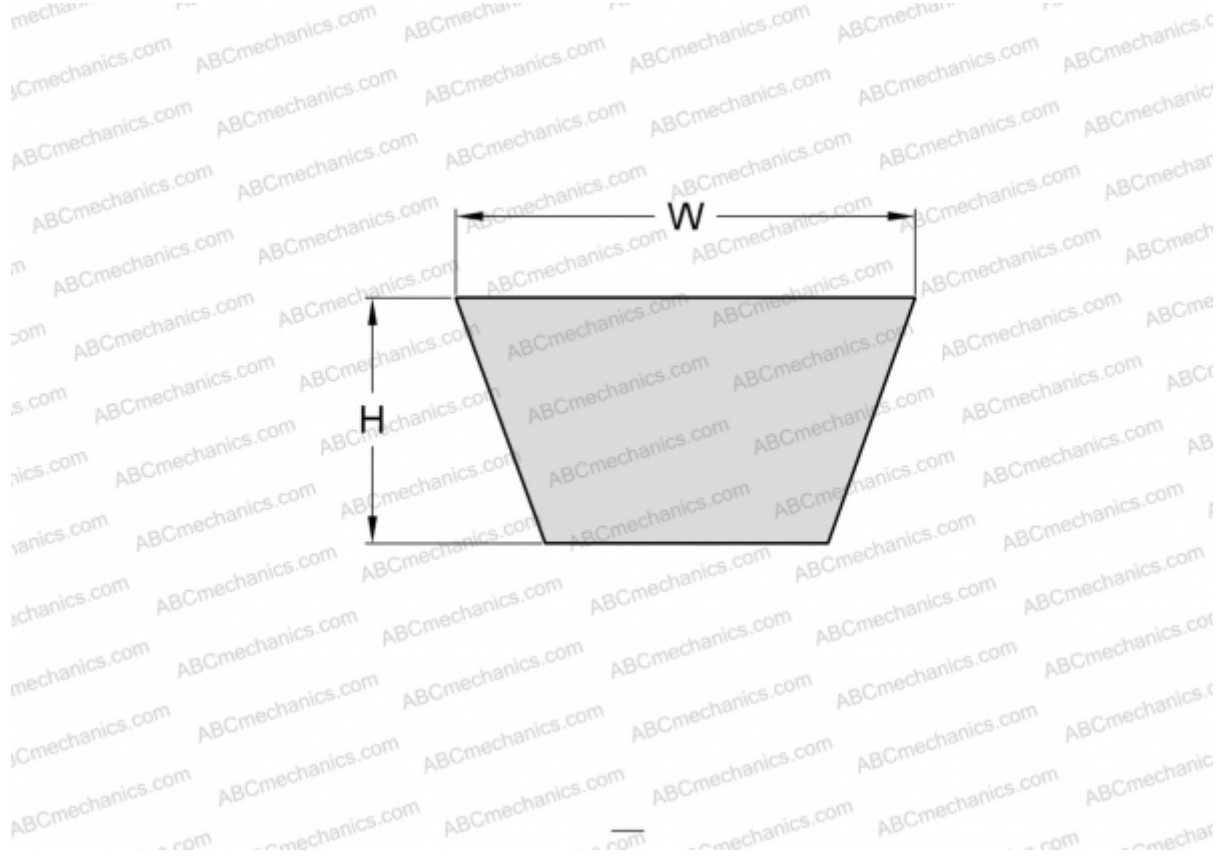

### Technical specification

#### DIMENSIONS, MM

Estimated length	7187,000
Inner length	7112,000
Width, W	38,000
Height, H	23,000

#### MANUFACTURER

[SKF](#)