

PHG E440 SKF

Wrapped classical belt

TYPE: V- belts, Classical, Wrapped, Section 38/E (SKF)

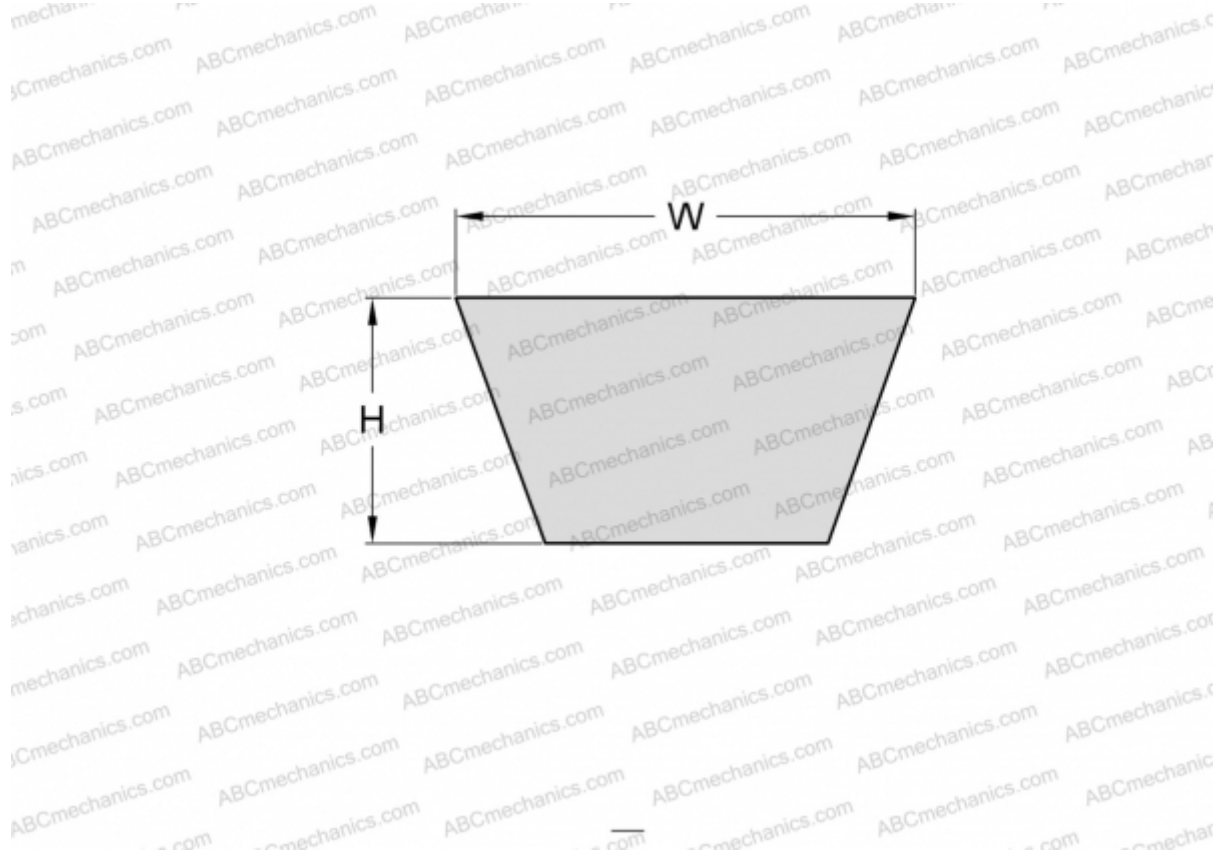

Technical specification

DIMENSIONS, MM

Estimated length	11247,000
Inner length	11176,000
Width, W	38,000
Height, H	23,000

MANUFACTURER

[SKF](#)