

PHG ZX34 SKF

Cogged raw edge classical belt

TYPE: V- belts, Classical, Cogged raw edge, Section X10/ZX (SKF)

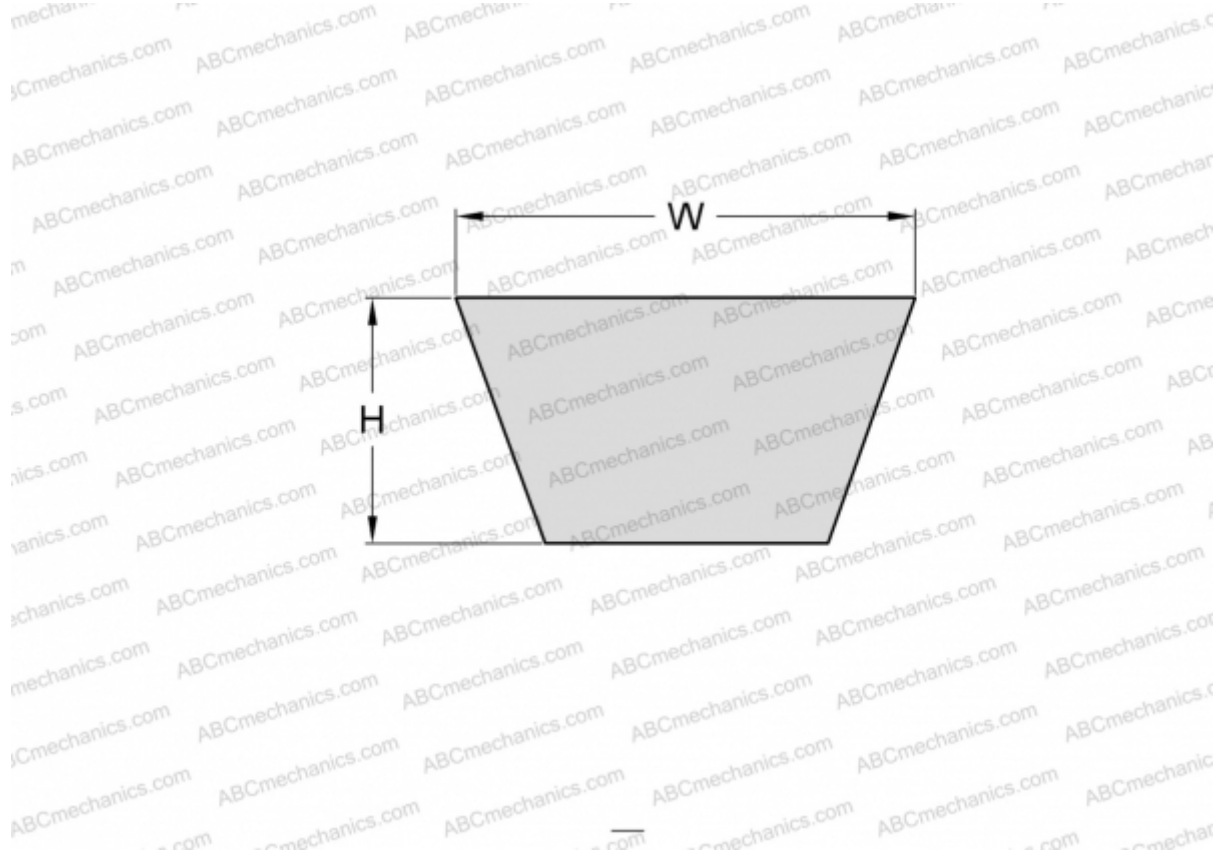

Technical specification

DIMENSIONS, MM

Estimated length	875,000
Inner length	864,000
Width, W	10,000
Height, H	6,000

MANUFACTURER

[SKF](#)