

PHG AX28 SKF

Cogged raw edge classical belt

TYPE: V- belts, Classical, Cogged raw edge, Section X13/AX (SKF)

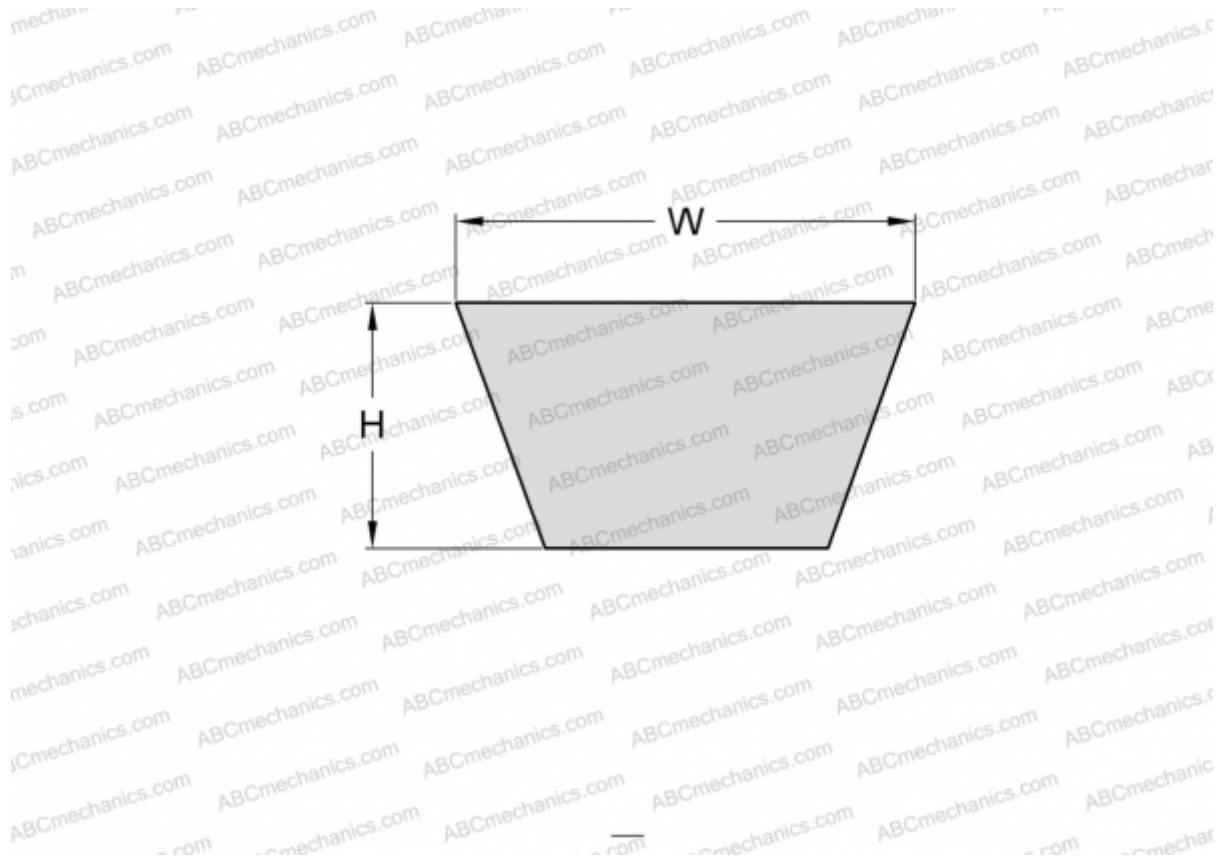

Technical specification

DIMENSIONS, MM

Estimated length	740,000
Inner length	711,000
Width, W	13,000
Height, H	8,000

MANUFACTURER [SKF](#)