

PHG AX75 SKF

Cogged raw edge classical belt

TYPE: V- belts, Classical, Cogged raw edge, Section X13/AX (SKF)

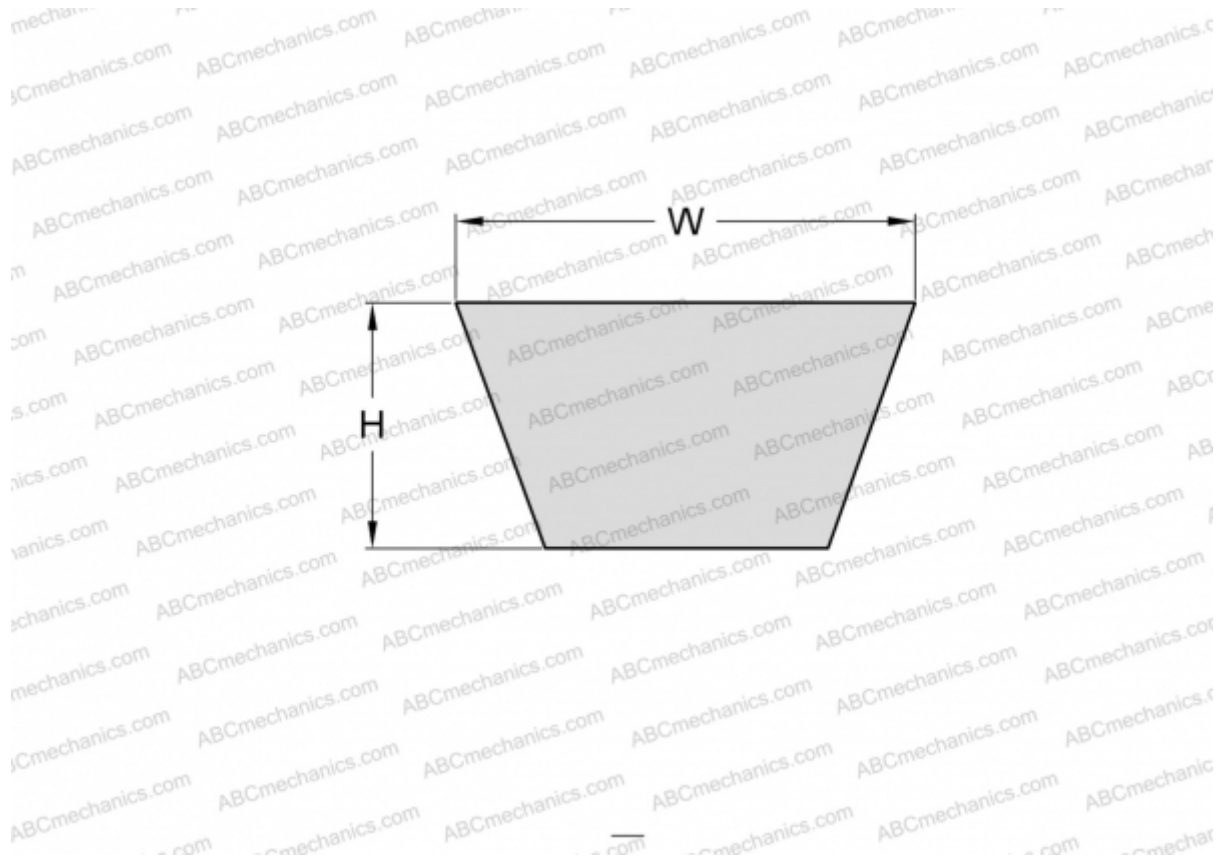

Technical specification

DIMENSIONS, MM

| | |
|------------------|----------|
| Estimated length | 1940,000 |
| Inner length | 1905,000 |
| Width, W | 13,000 |
| Height, H | 8,000 |

MANUFACTURER

[SKF](#)