

## PHG AX98 SKF

Cogged raw edge classical belt

TYPE: V- belts, Classical, Cogged raw edge, Section X13/AX (SKF)

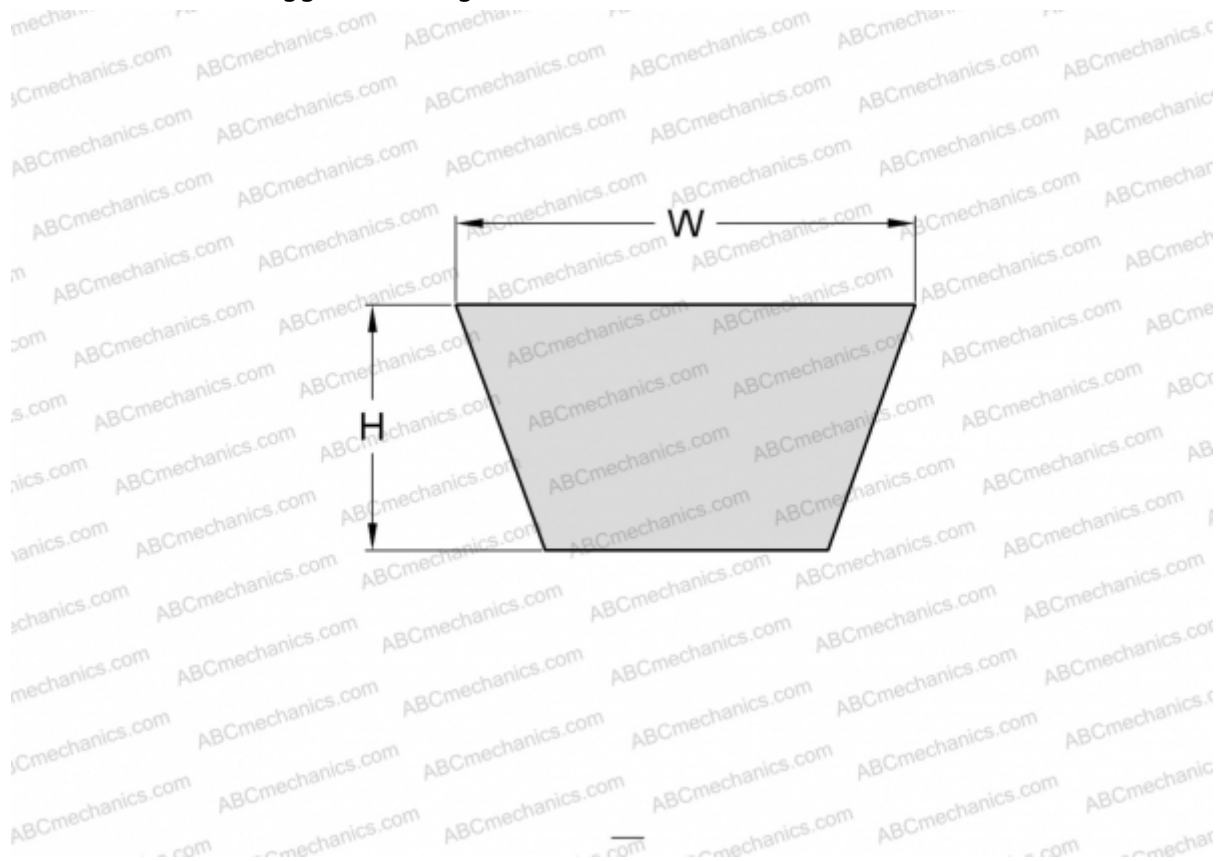

### Technical specification

#### DIMENSIONS, MM

Estimated length	2520,000
Inner length	2489,000
Width, W	13,000
Height, H	8,000

#### MANUFACTURER

[SKF](#)