

## PHG BX88 SKF

Cogged raw edge classical belt

TYPE: V- belts, Classical, Cogged raw edge, Section X17/BX (SKF)

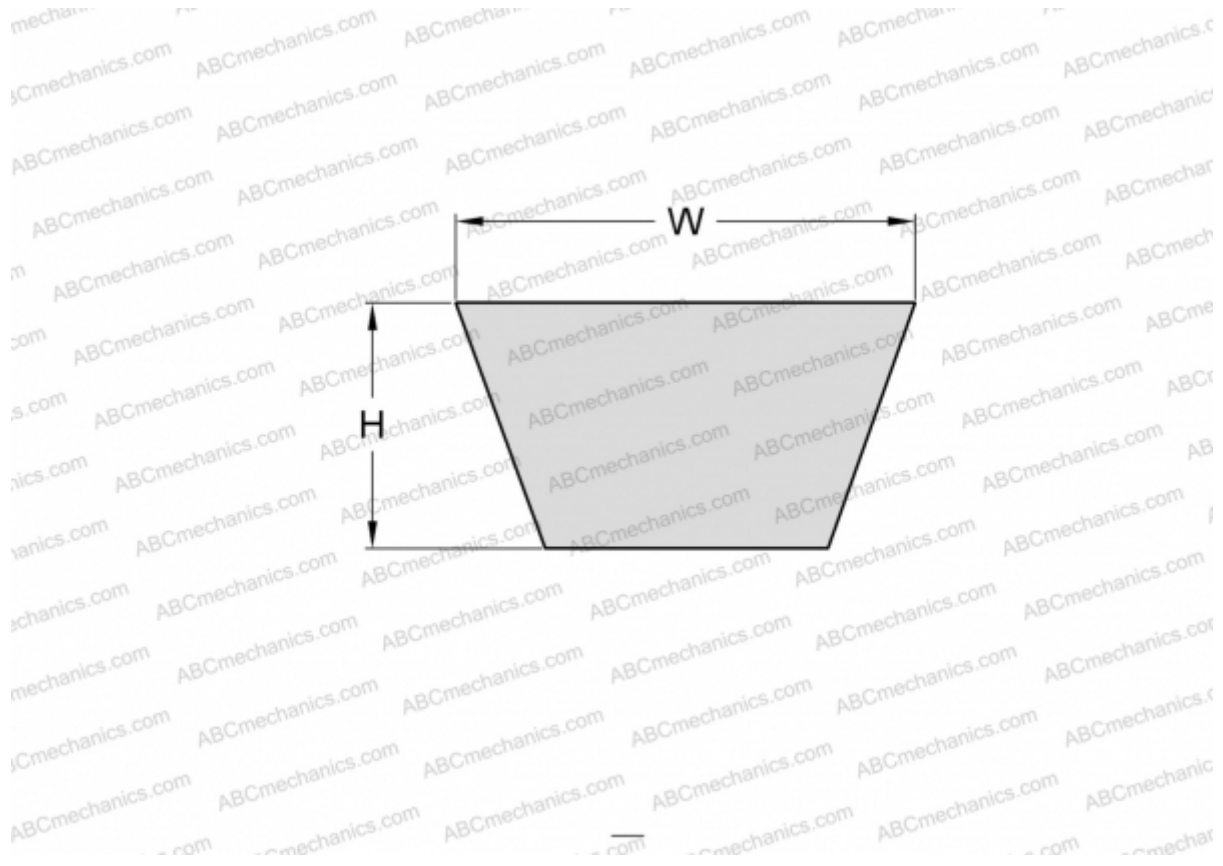

### Technical specification

#### DIMENSIONS, MM

Estimated length	2280,000
Inner length	2235,000
Width, W	17,000
Height, H	11,000

#### MANUFACTURER

[SKF](#)