

PHG BX92 SKF

Cogged raw edge classical belt

TYPE: V- belts, Classical, Cogged raw edge, Section X17/BX (SKF)

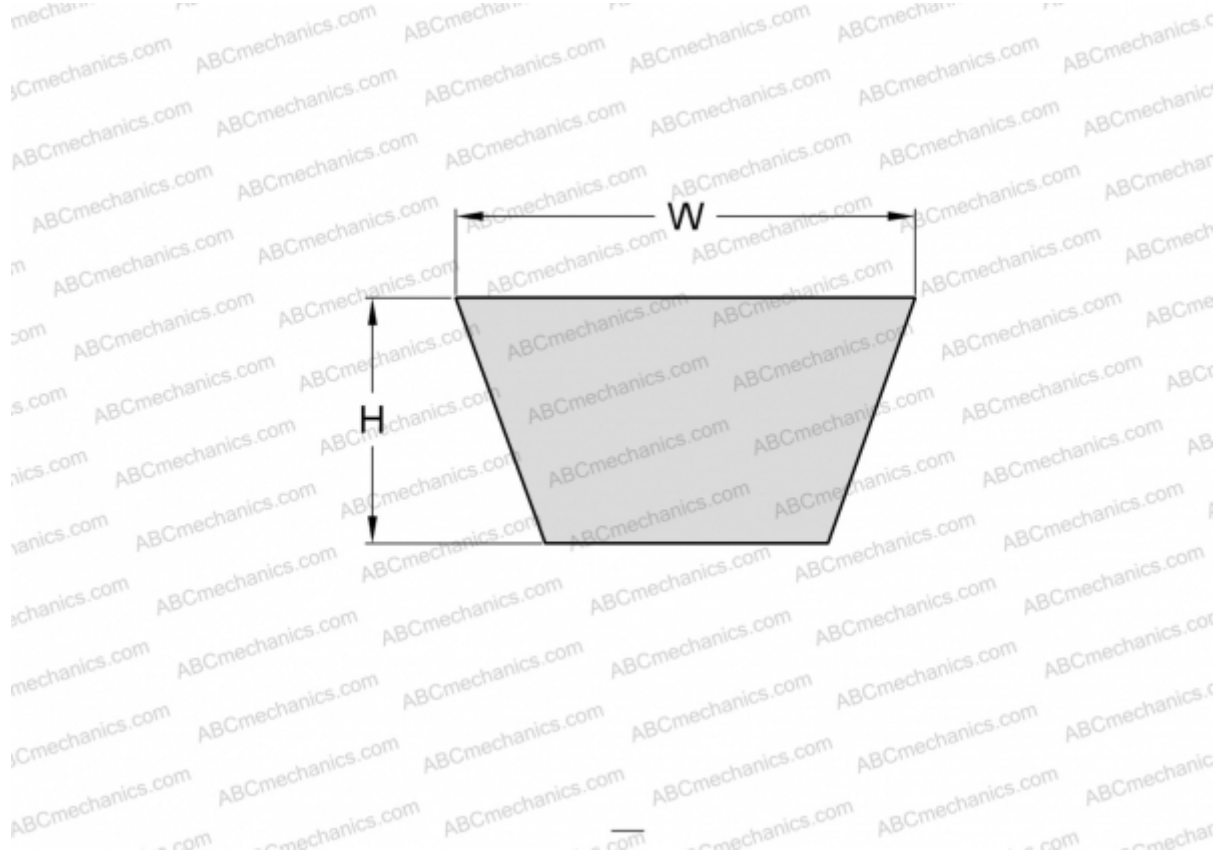

Technical specification

DIMENSIONS, MM

Estimated length	2380,000
Inner length	2337,000
Width, W	17,000
Height, H	11,000

MANUFACTURER

[SKF](#)