

## PHG CX52 SKF

Cogged raw edge classical belt

TYPE: V- belts, Classical, Cogged raw edge, Section X22/CX (SKF)

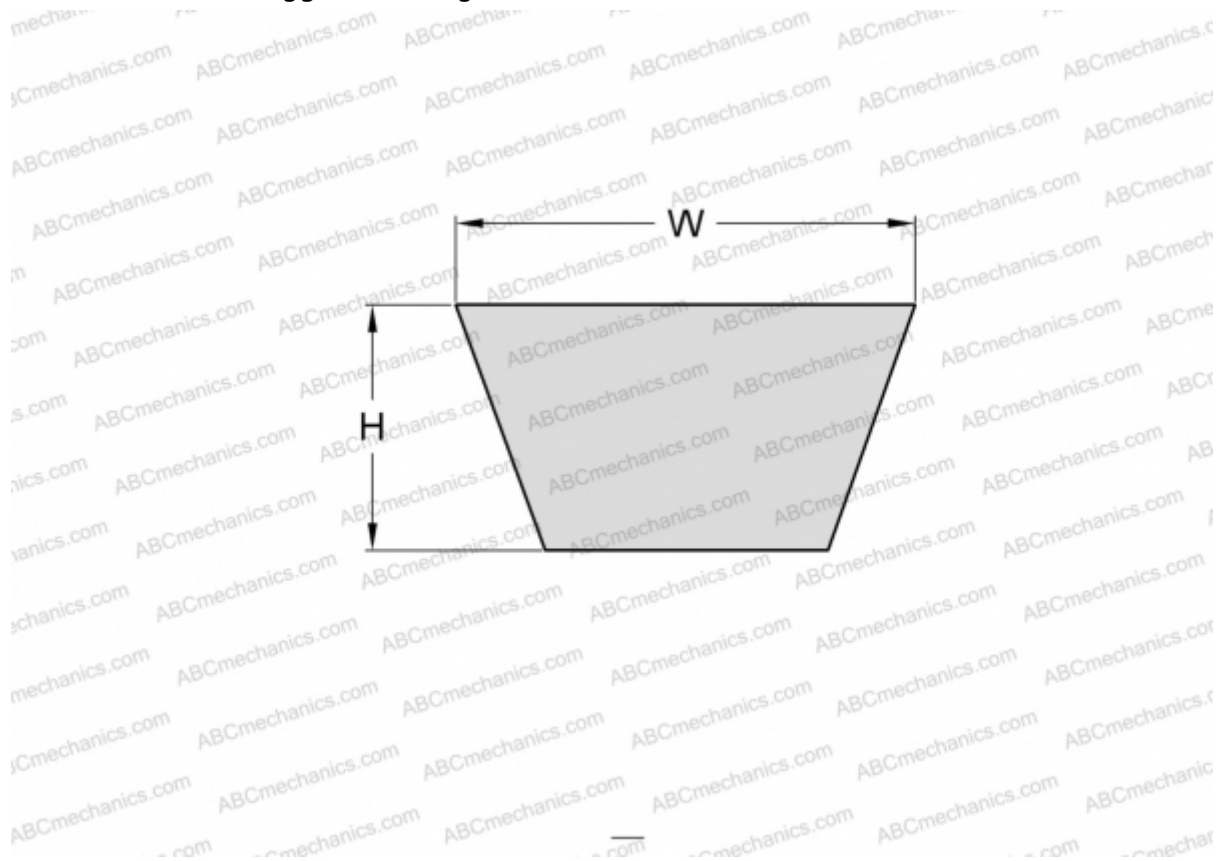

### Technical specification

#### DIMENSIONS, MM

Estimated length	1370,000
Inner length	1321,000
Width, W	22,000
Height, H	14,000

#### MANUFACTURER

[SKF](#)