

PHG CX115 SKF

Cogged raw edge classical belt

TYPE: V- belts, Classical, Cogged raw edge, Section X22/CX (SKF)

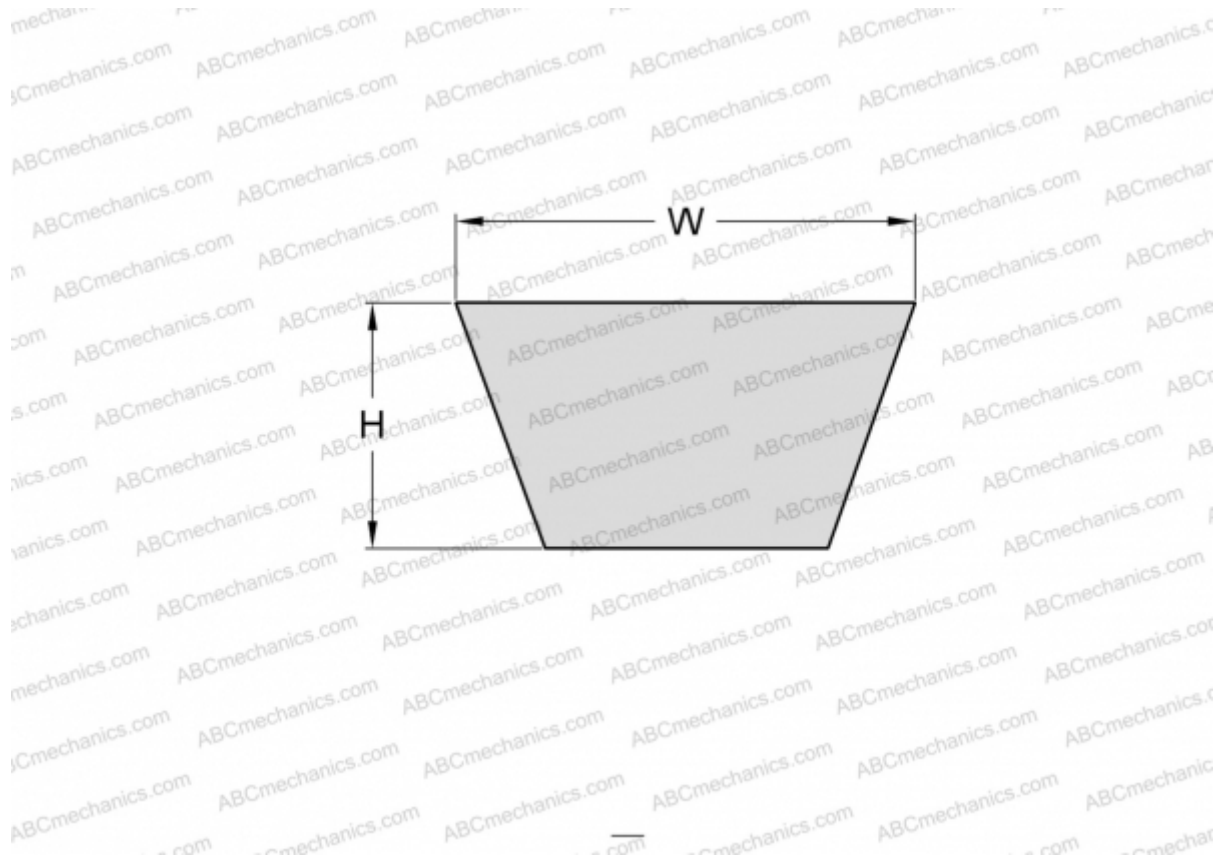

Technical specification

DIMENSIONS, MM

Estimated length	2980,000
Inner length	2921,000
Width, W	22,000
Height, H	14,000

MANUFACTURER

[SKF](#)