

## PHG 3V265 SKF

Wrapped narrow wedge belt

TYPE: V- belts, Narrow, Standart ANSI (USA), Section 3V/9N (SKF)

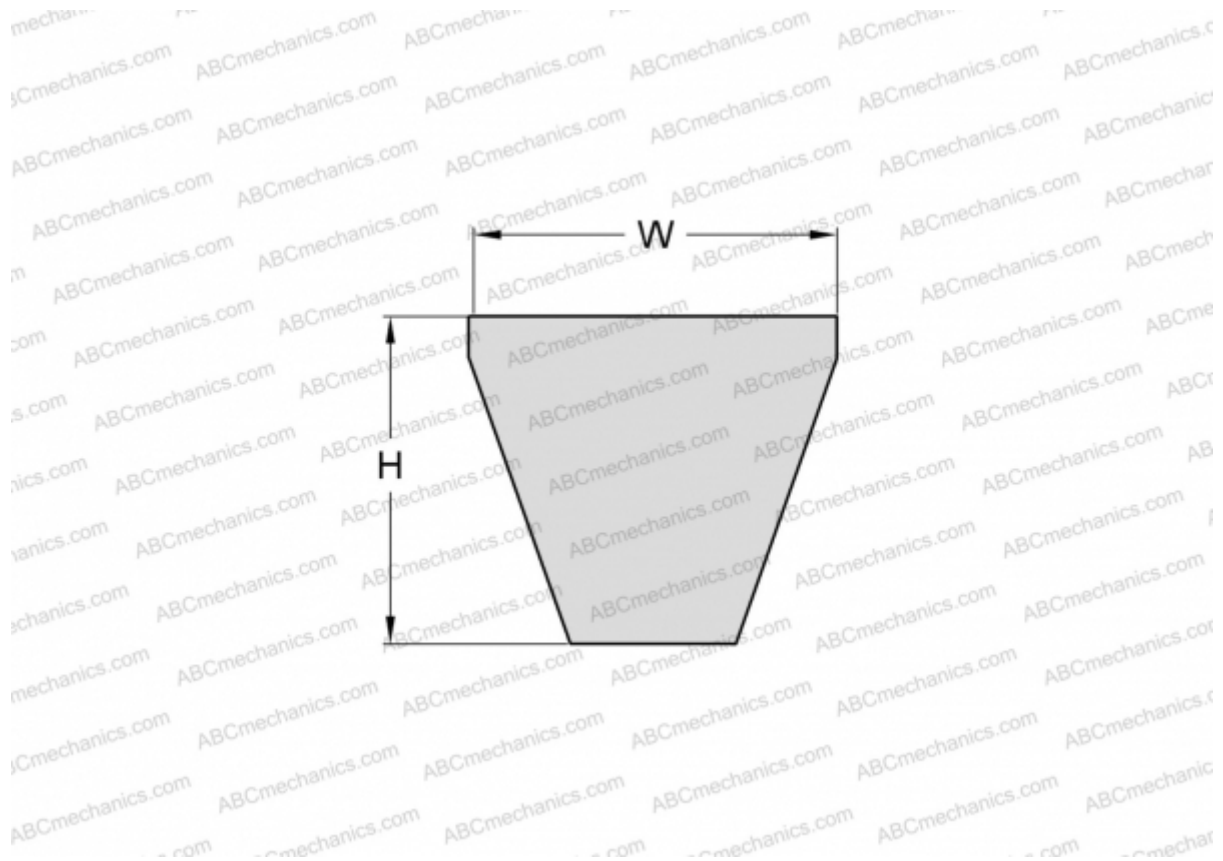

### Technical specification

#### DIMENSIONS, MM

Estimated length	673,000
Width, W	9,000
Height, H	8,000

#### MANUFACTURER

[SKF](#)