

PHG 3V425 SKF

Wrapped narrow wedge belt

TYPE: V- belts, Narrow, Standart ANSI (USA), Section 3V/9N (SKF)

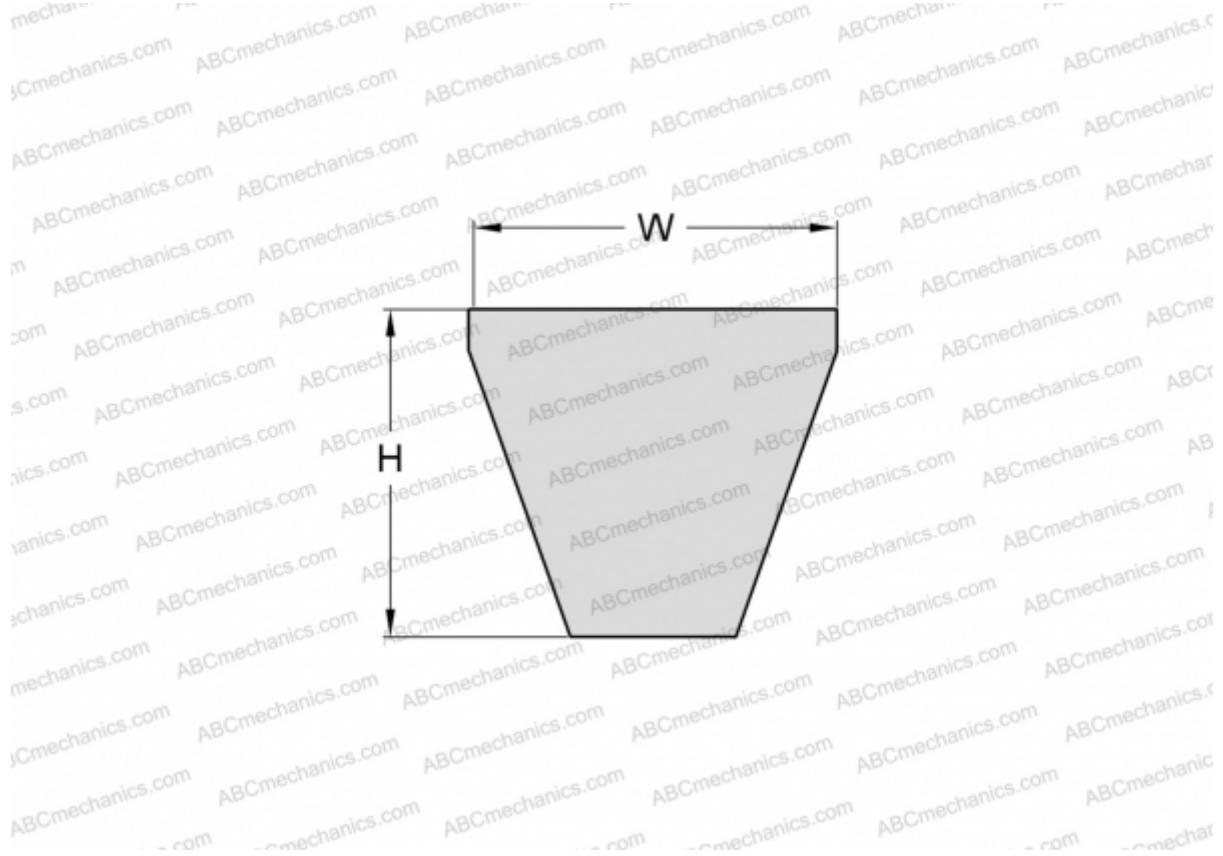

Technical specification

DIMENSIONS, MM

Estimated length	1080,000
Width, W	9,000
Height, H	8,000

MANUFACTURER

[SKF](#)