

## PHG 5V3000 SKF

Wrapped narrow wedge belt

TYPE: V- belts, Narrow, Standart ANSI (USA), Section 5V/15N (SKF)

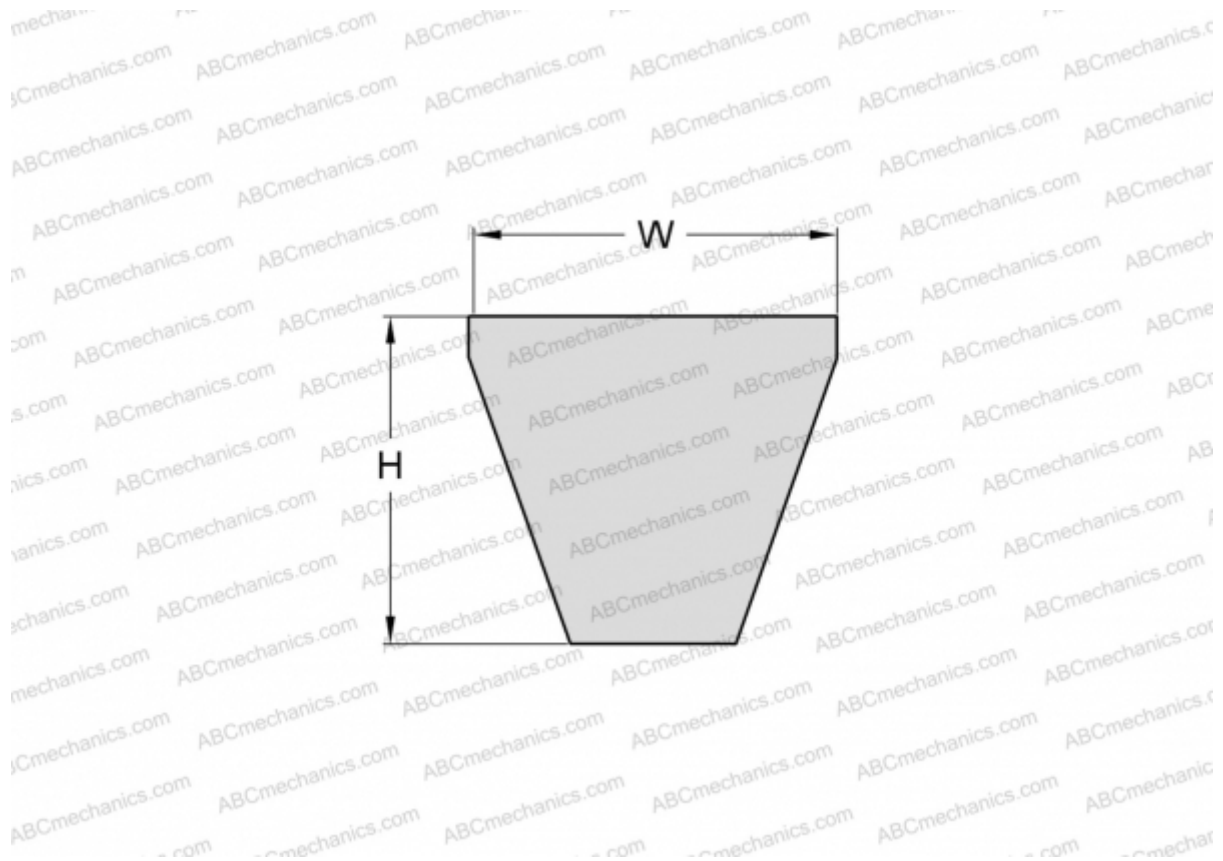

### Technical specification

#### DIMENSIONS, MM

Estimated length	7620,000
Width, W	15,000
Height, H	13,000

#### MANUFACTURER

[SKF](#)