

PHG 5V3150 SKF

Wrapped narrow wedge belt

TYPE: V- belts, Narrow, Standart ANSI (USA), Section 5V/15N (SKF)

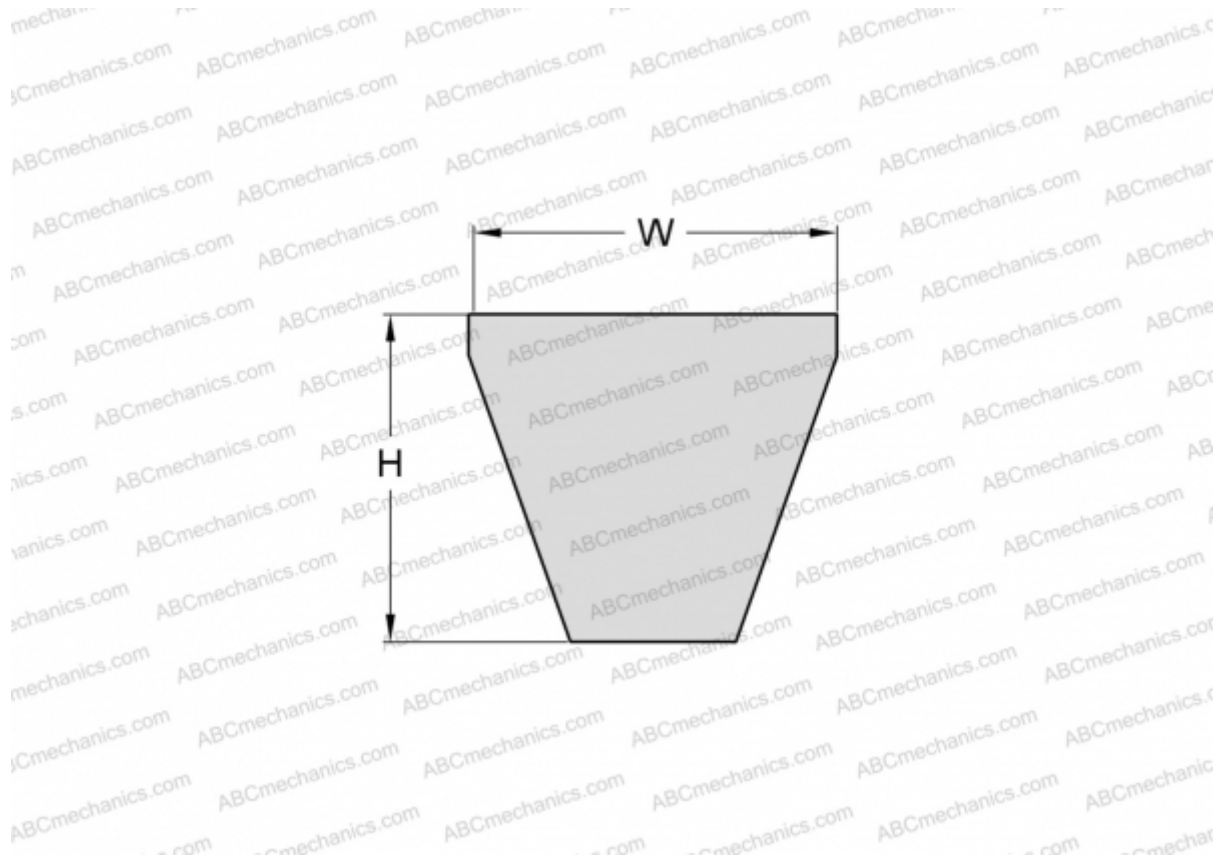

Technical specification

DIMENSIONS, MM

Estimated length	8001,000
Width, W	15,000
Height, H	13,000

MANUFACTURER

[SKF](#)