

## PHG 8V3150 SKF

Wrapped narrow wedge belt

TYPE: V- belts, Narrow, Standart ANSI (USA), Section 8V/25N (SKF)

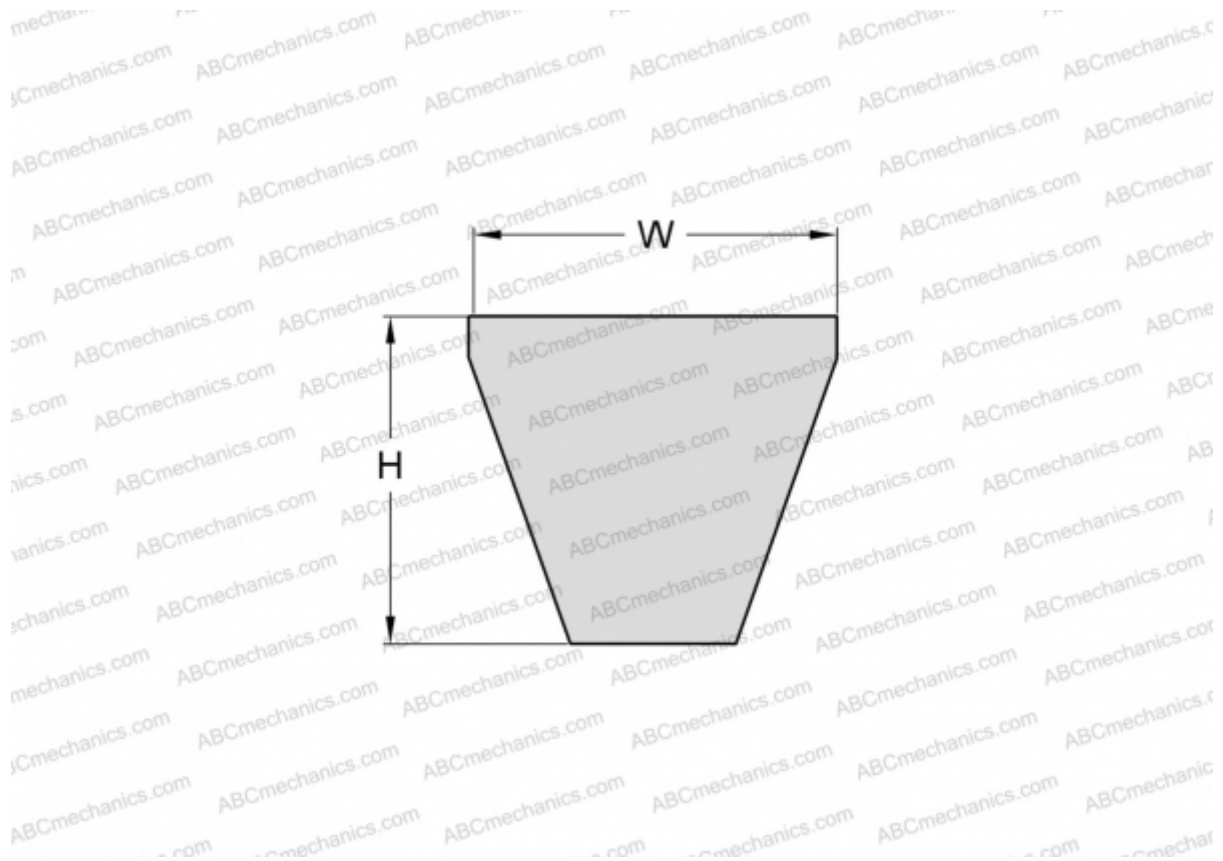

### Technical specification

#### DIMENSIONS, MM

Estimated length	8001,000
Width, W	25,000
Height, H	23,000

#### MANUFACTURER

[SKF](#)