

PHG XPZ800 SKF

Cogged raw edge wedge belt

TYPE: V- belts, Narrow, Cogged raw edge, Section XPZ (SKF)

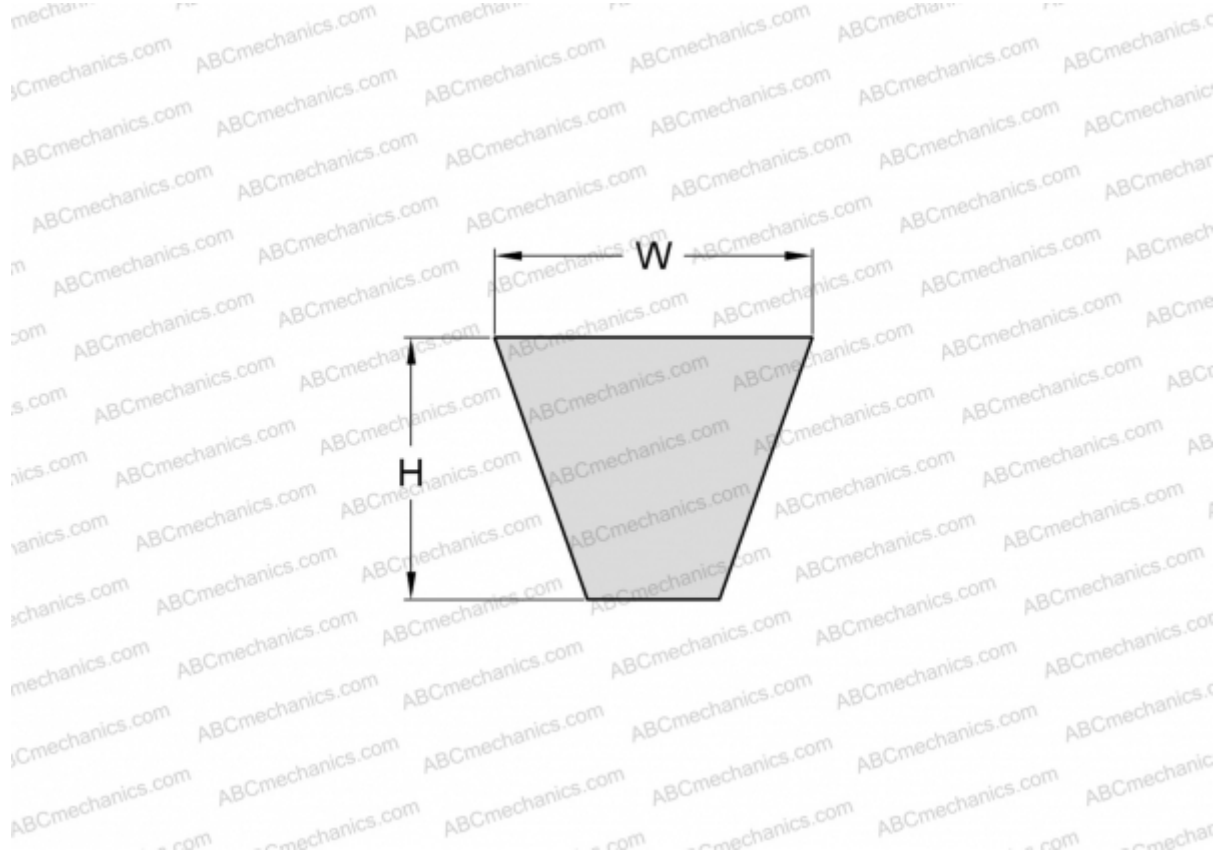

Technical specification

DIMENSIONS, MM

Estimated length	800,000
Width, W	9,700
Height, H	8,000

MANUFACTURER

[SKF](#)