

## PHG XPZ837 SKF

Cogged raw edge wedge belt

TYPE: V- belts, Narrow, Cogged raw edge, Section XPZ (SKF)

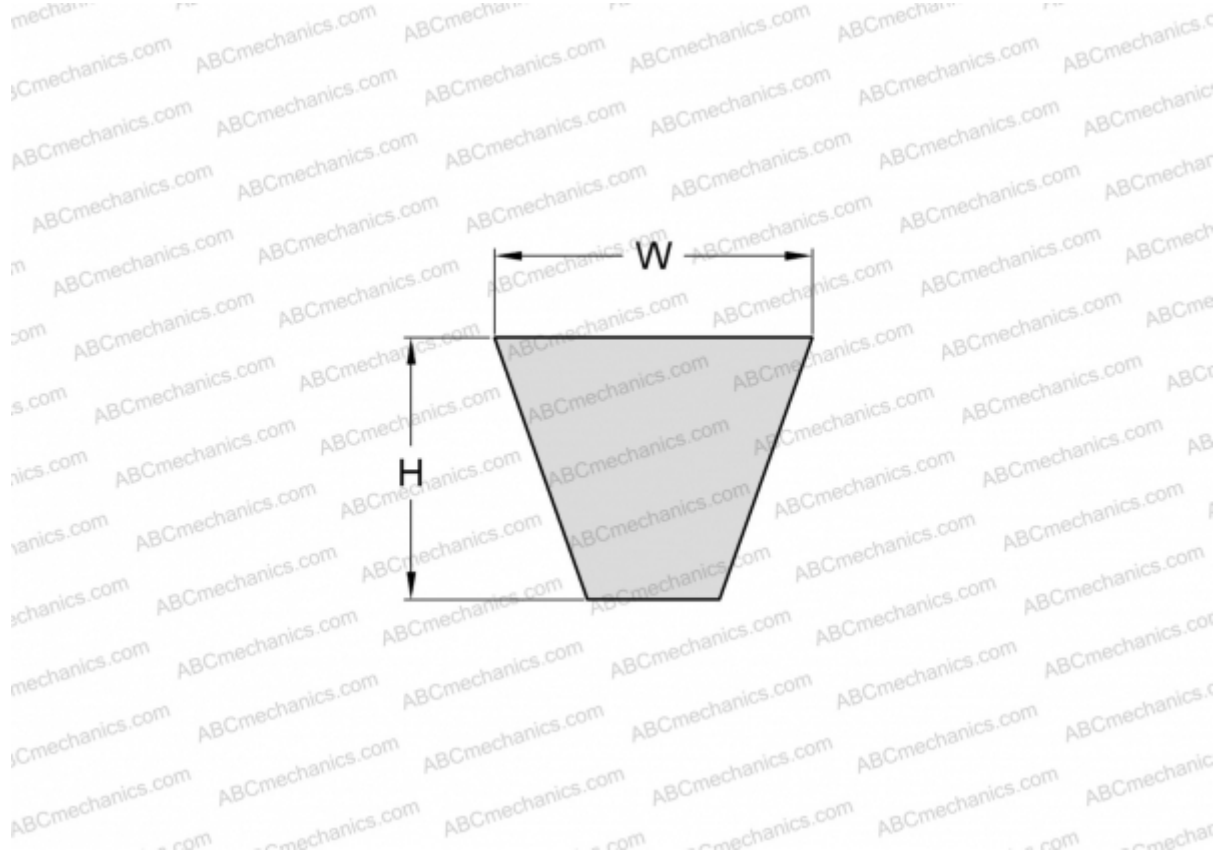

### Technical specification

#### DIMENSIONS, MM

Estimated length	837,000
Width, W	9,700
Height, H	8,000

#### MANUFACTURER

[SKF](#)