

## PHG 3VX300 SKF

Cogged raw edge narrow wedge belt

TYPE: V- belts, Narrow, Cogged standart ANSI (USA), Section 3VX/9NX (SKF)

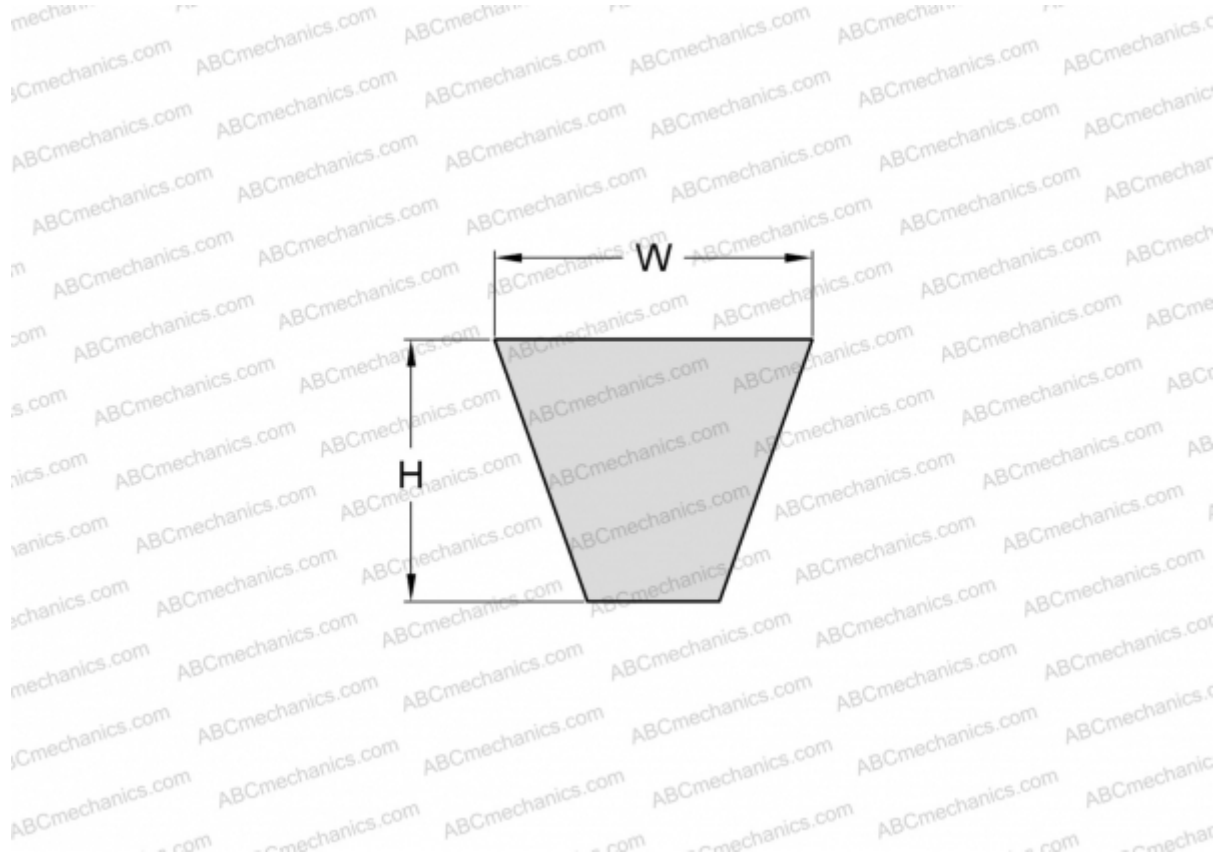

### Technical specification

#### DIMENSIONS, MM

Estimated length	762,000
Width, W	9,000
Height, H	8,000

#### MANUFACTURER

[SKF](#)