

PHG 3VX1250 SKF

Cogged raw edge narrow wedge belt

TYPE: V- belts, Narrow, Cogged standart ANSI (USA), Section 3VX/9NX (SKF)

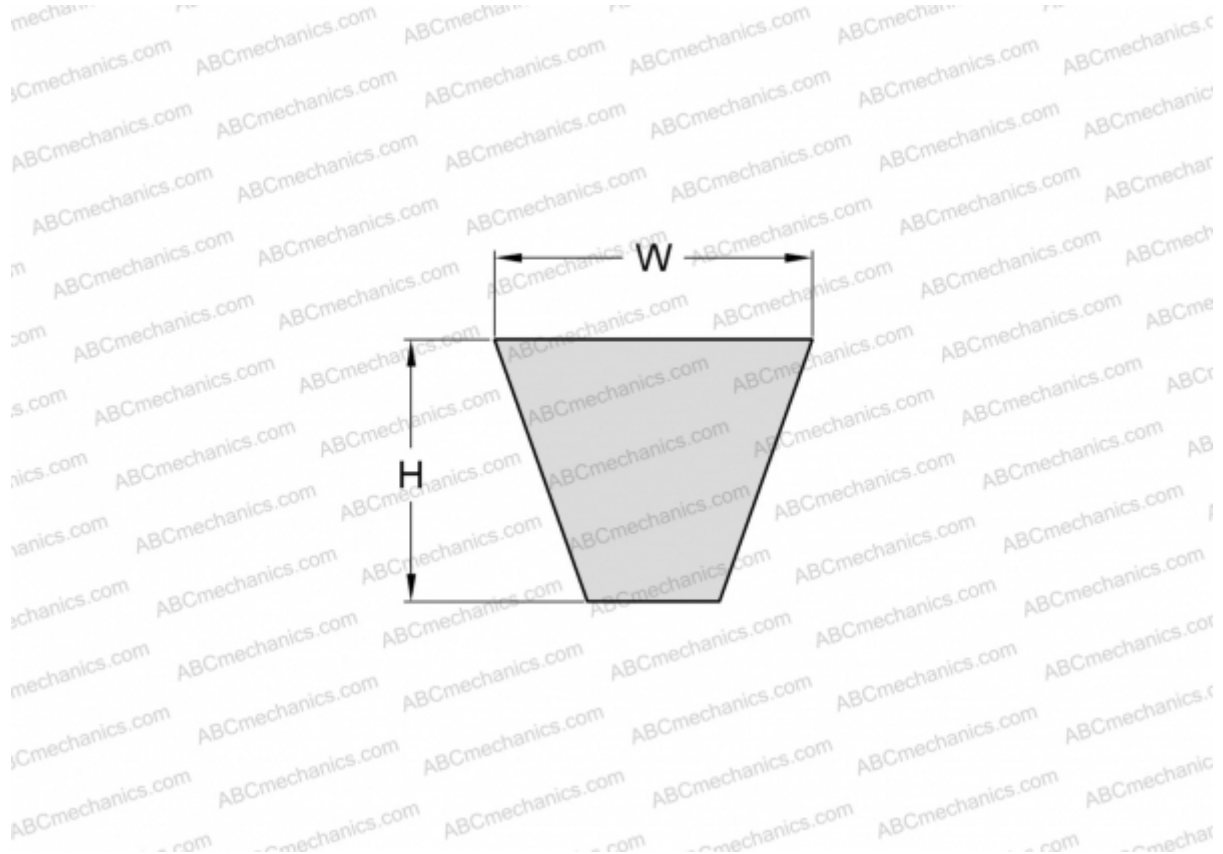

Technical specification

DIMENSIONS, MM

Estimated length	3175,000
Width, W	9,000
Height, H	8,000

MANUFACTURER

[SKF](#)