

PHG 5VX1600 SKF

Cogged raw edge narrow wedge belt

TYPE: V- belts, Narrow, Cogged standart ANSI (USA), Section 5VX/15NX (SKF)

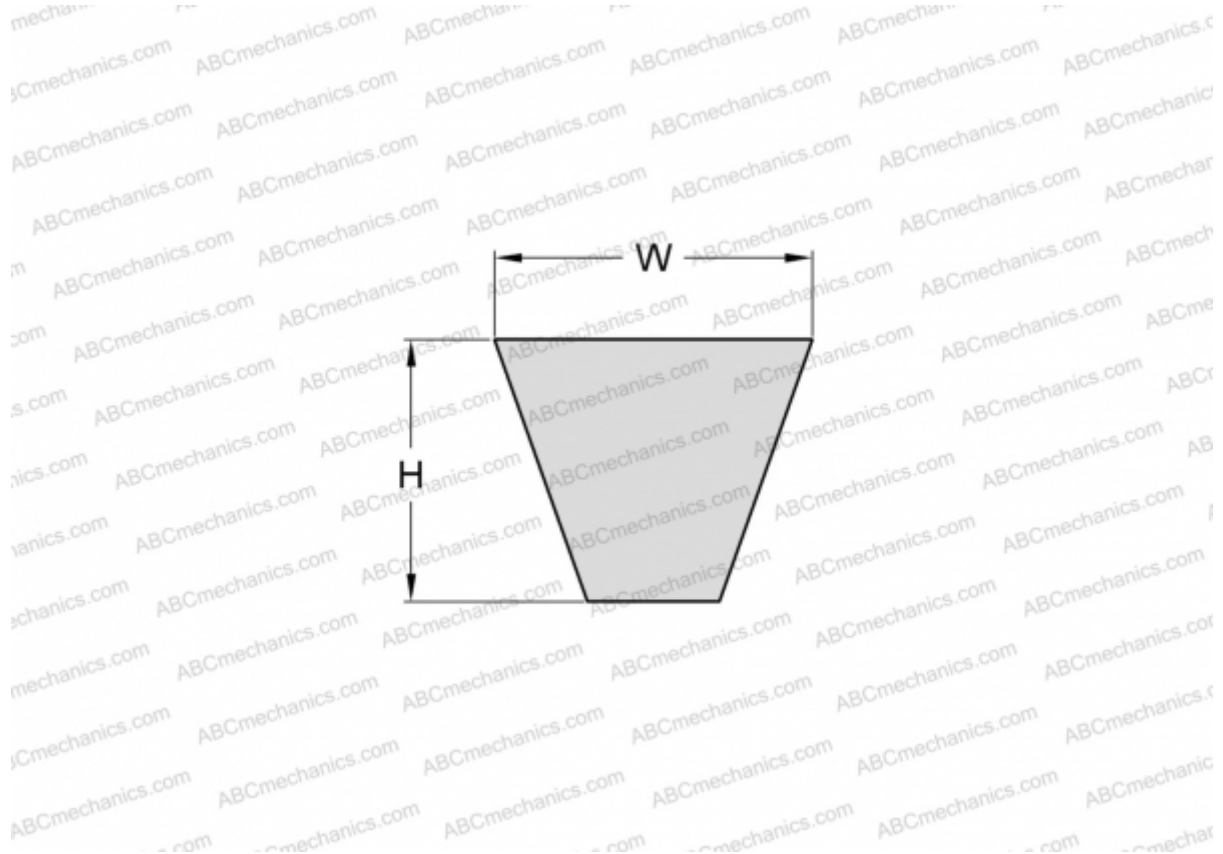

Technical specification

DIMENSIONS, MM

Estimated length	4064,000
Width, W	15,000
Height, H	13,000

MANUFACTURER

[SKF](#)