

PHG VS17X5X776 SKF

Variable speed belt

TYPE: V- belts, Variable speed belts, Section VS (SKF)

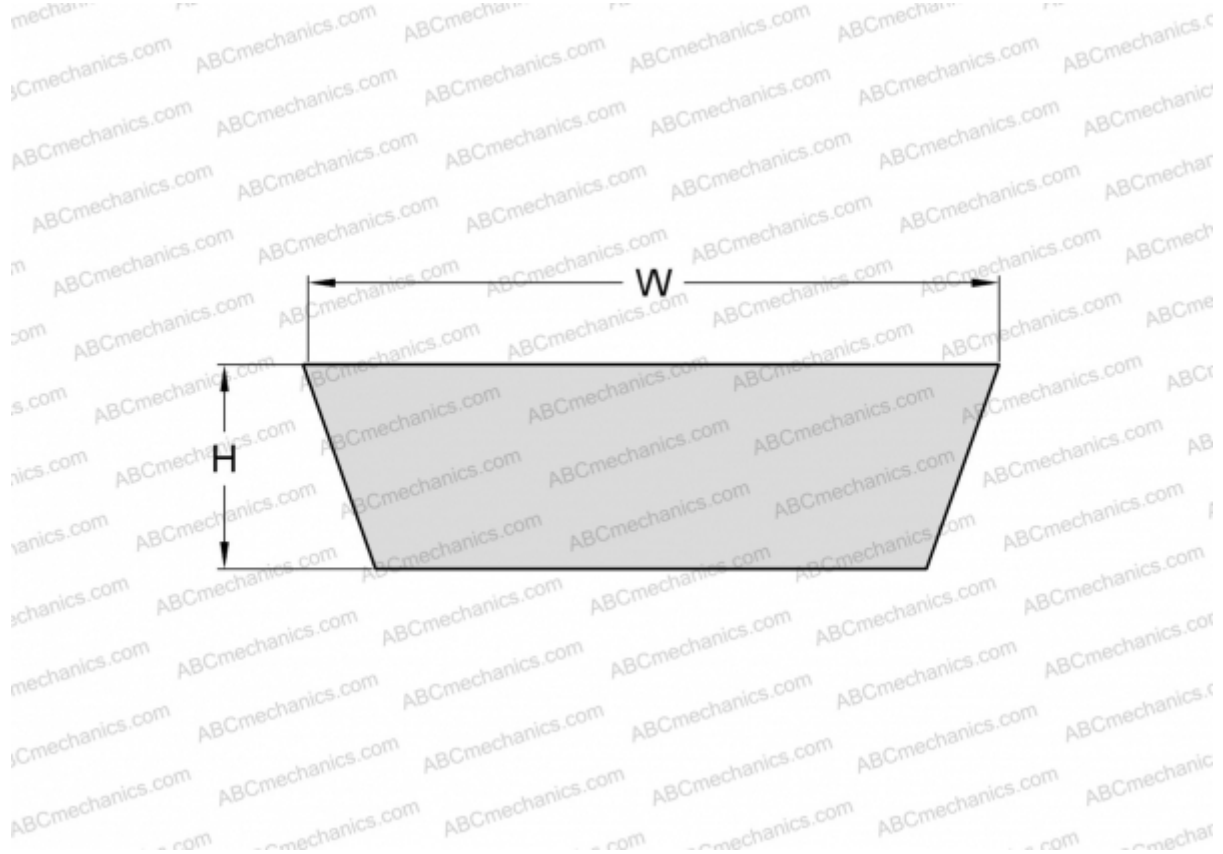

Technical specification

DIMENSIONS, MM

Estimated length	796,000
Inner length	776,000
Width, W	17,000
Height, H	5,000
Number of teeth	1

MANUFACTURER

[SKF](#)