

PHG VS21X6X675 SKF

Variable speed belt

TYPE: V- belts, Variable speed belts, Section VS (SKF)

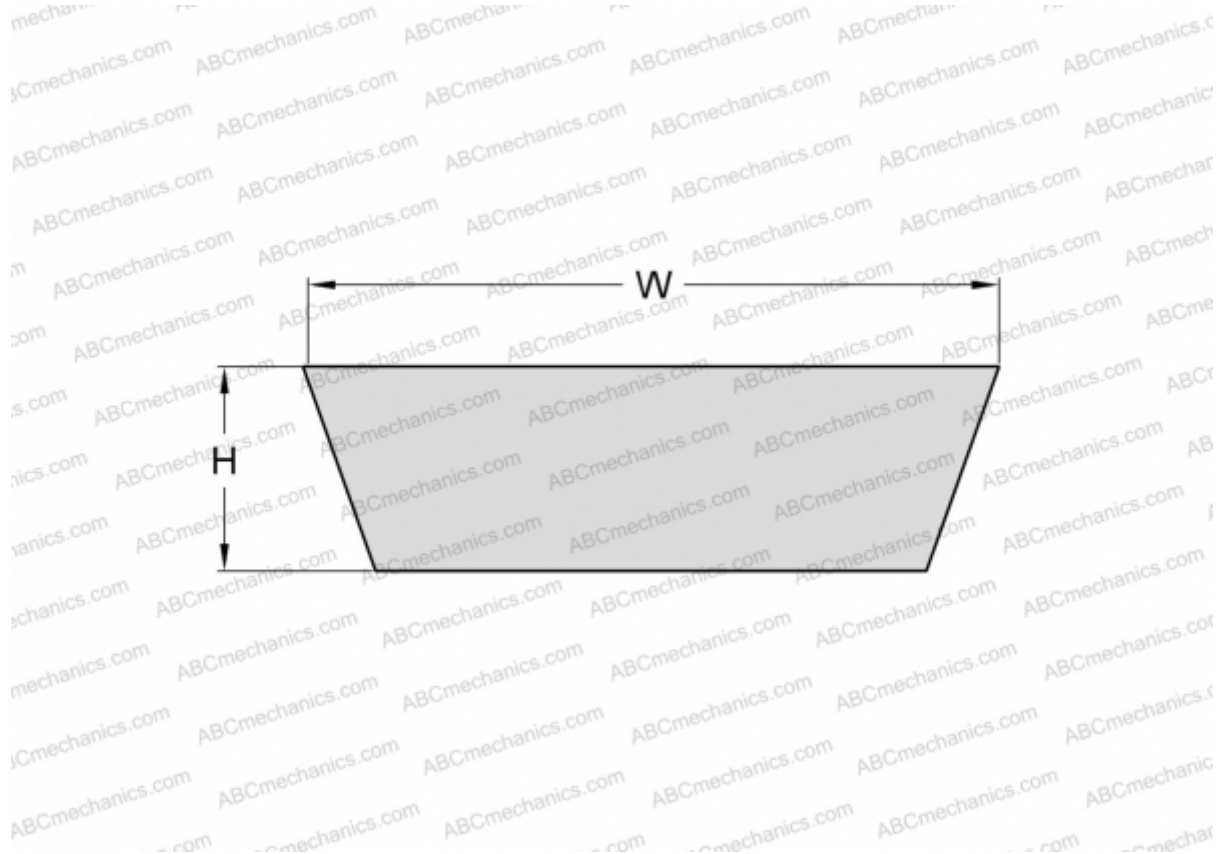

Technical specification

DIMENSIONS, MM

Estimated length	695,000
Inner length	675,000
Width, W	21,000
Height, H	6,000
Number of teeth	1

MANUFACTURER

[SKF](#)