

## PHG VS22X8X750 SKF

Variable speed belt

TYPE: V- belts, Variable speed belts, Section VS (SKF)

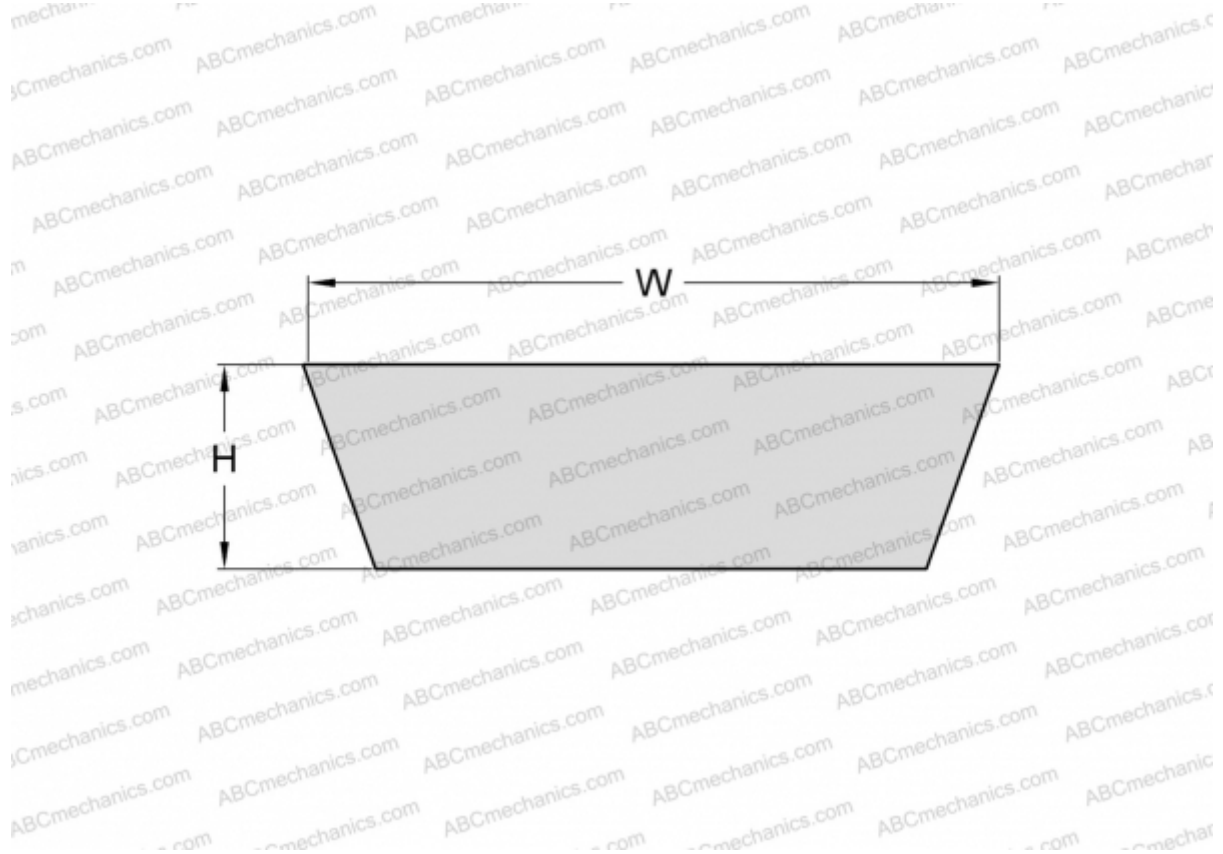

### Technical specification

#### DIMENSIONS, MM

Estimated length	781,000
Inner length	750,000
Width, W	22,000
Height, H	8,000
Number of teeth	1

#### MANUFACTURER

[SKF](#)