

PHG VS22X8X900 SKF

Variable speed belt

TYPE: V- belts, Variable speed belts, Section VS (SKF)

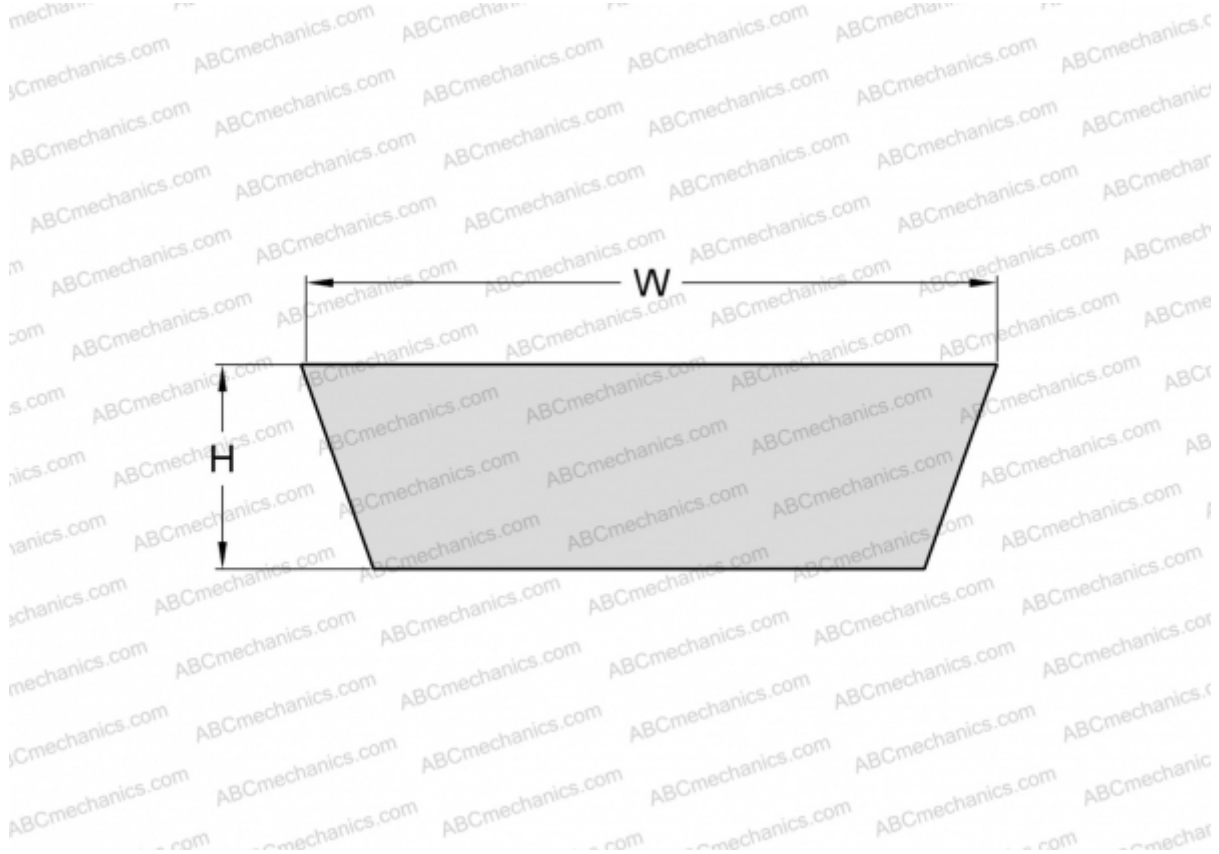

Technical specification

DIMENSIONS, MM

Estimated length	931,000
Inner length	900,000
Width, W	22,000
Height, H	8,000
Number of teeth	1

MANUFACTURER

[SKF](#)