

PHG VS28X8X650 SKF

Variable speed belt

TYPE: V- belts, Variable speed belts, Section VS (SKF)

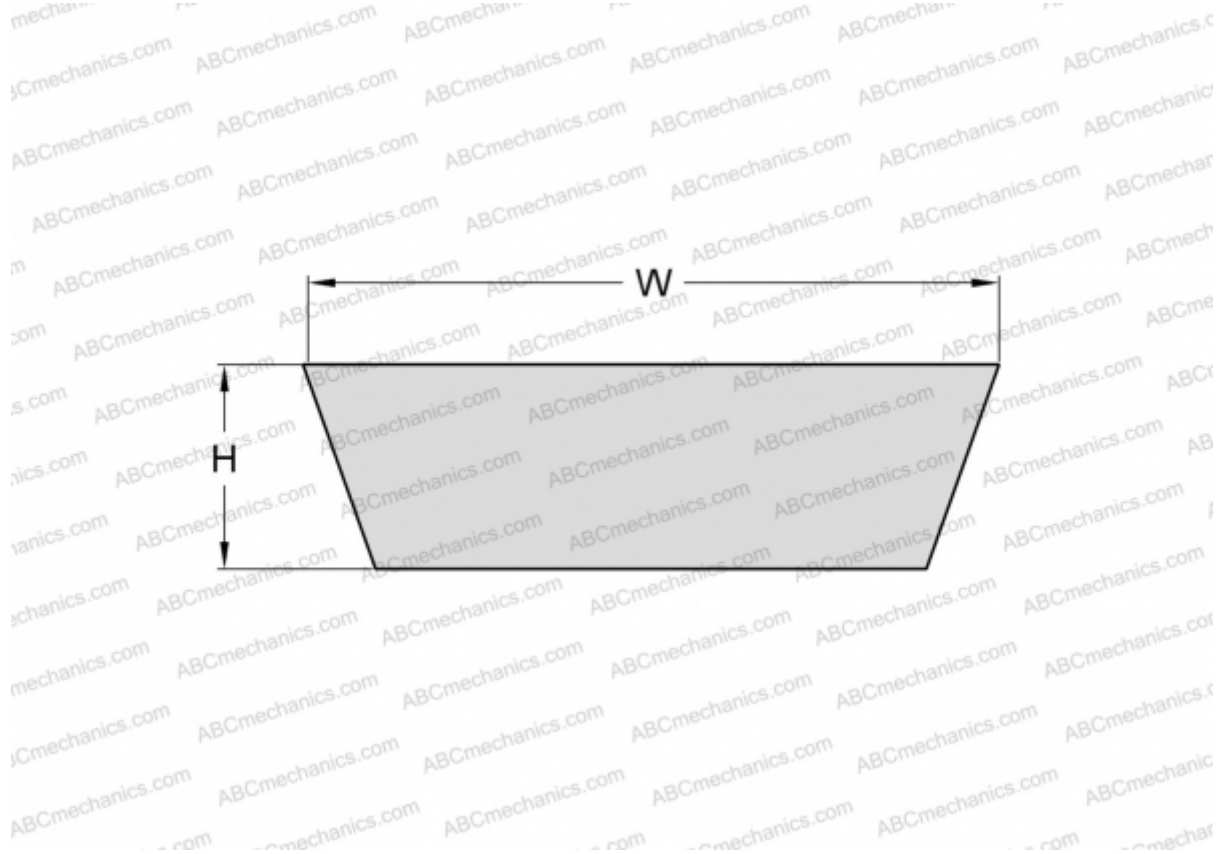

Technical specification

DIMENSIONS, MM

Estimated length	681,000
Inner length	650,000
Width, W	28,000
Height, H	8,000
Number of teeth	1

MANUFACTURER

[SKF](#)