

PHG VS32X10X1180 SKF

Variable speed belt

TYPE: V- belts, Variable speed belts, Section VS (SKF)

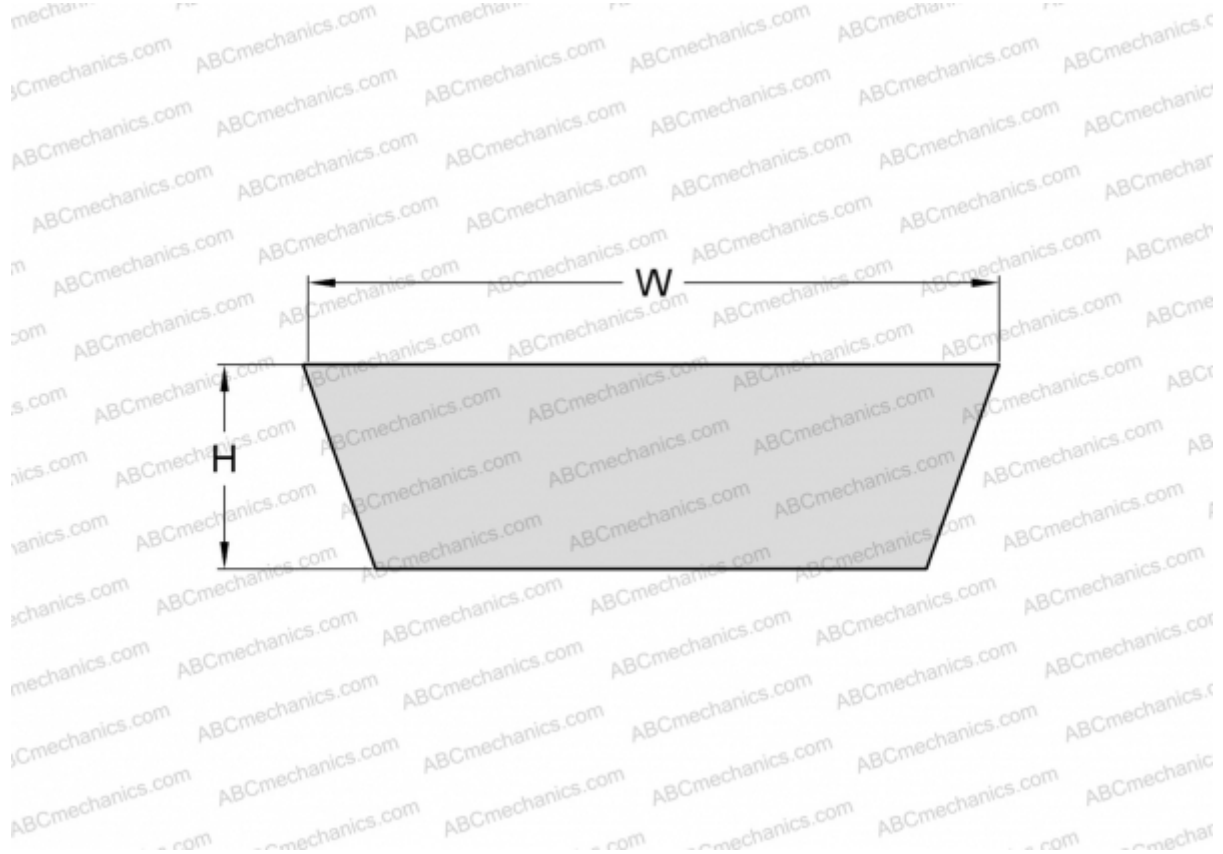

Technical specification

DIMENSIONS, MM

Estimated length	1222,000
Inner length	1180,000
Width, W	32,000
Height, H	10,000
Number of teeth	1

MANUFACTURER

[SKF](#)