

## PHG VS37X10X850 SKF

Variable speed belt

TYPE: V- belts, Variable speed belts, Section VS (SKF)

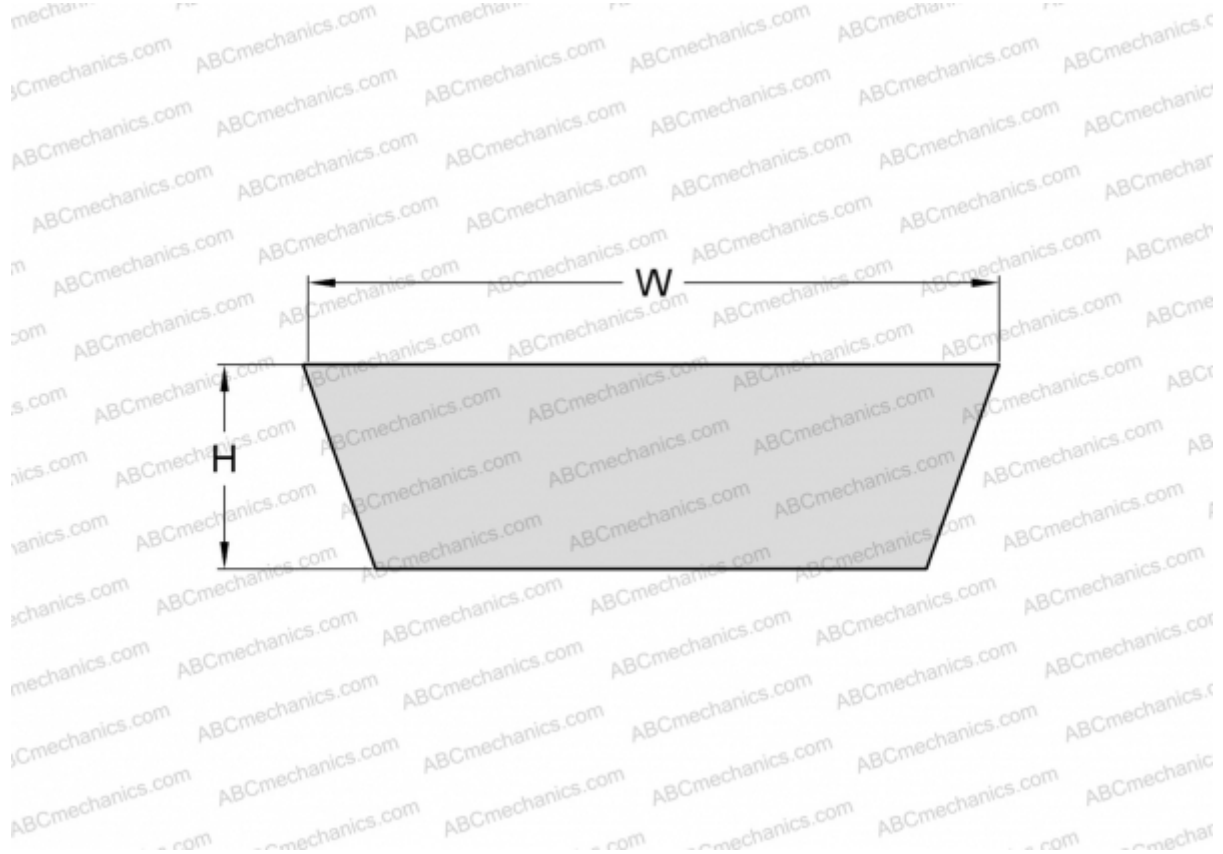

### Technical specification

#### DIMENSIONS, MM

Estimated length	892,000
Inner length	850,000
Width, W	37,000
Height, H	10,000
Number of teeth	1

#### MANUFACTURER

[SKF](#)