

## PHG VS37X10X900 SKF

Variable speed belt

TYPE: V- belts, Variable speed belts, Section VS (SKF)

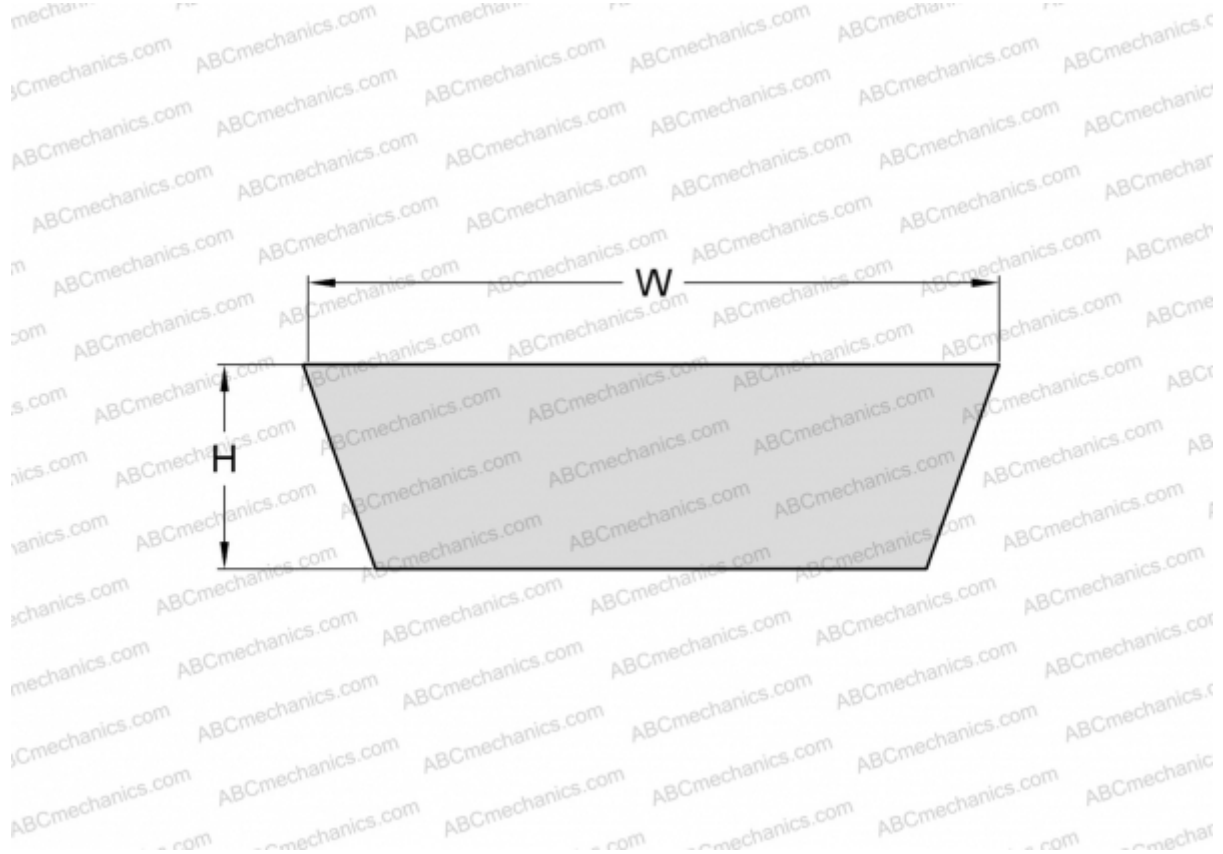

### Technical specification

#### DIMENSIONS, MM

Estimated length	942,000
Inner length	900,000
Width, W	37,000
Height, H	10,000
Number of teeth	1

#### MANUFACTURER

[SKF](#)