

PHG VS37X10X1120 SKF

Variable speed belt

TYPE: V- belts, Variable speed belts, Section VS (SKF)

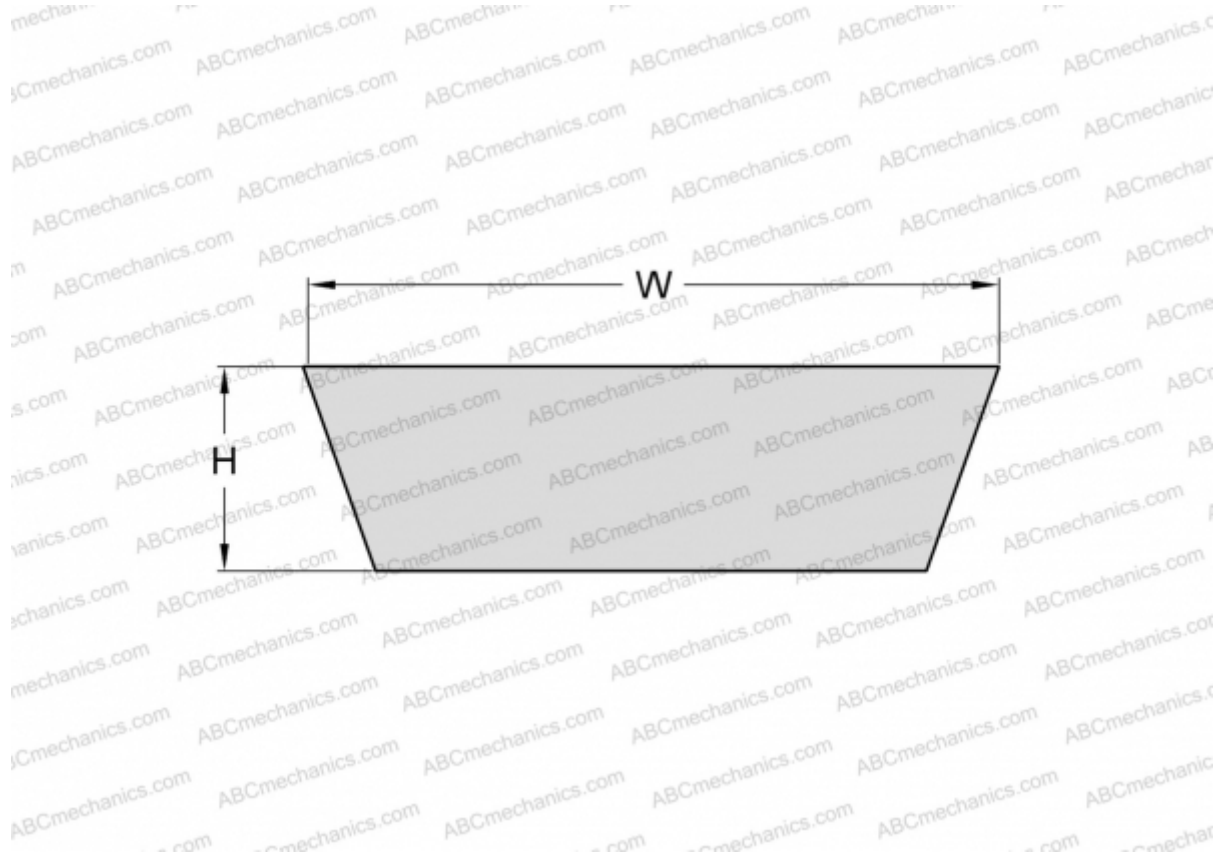

Technical specification

DIMENSIONS, MM

Estimated length	1162,000
Inner length	1120,000
Width, W	37,000
Height, H	10,000
Number of teeth	1

MANUFACTURER

[SKF](#)