

PHG VS41X13X1600 SKF

Variable speed belt

TYPE: V- belts, Variable speed belts, Section VS (SKF)

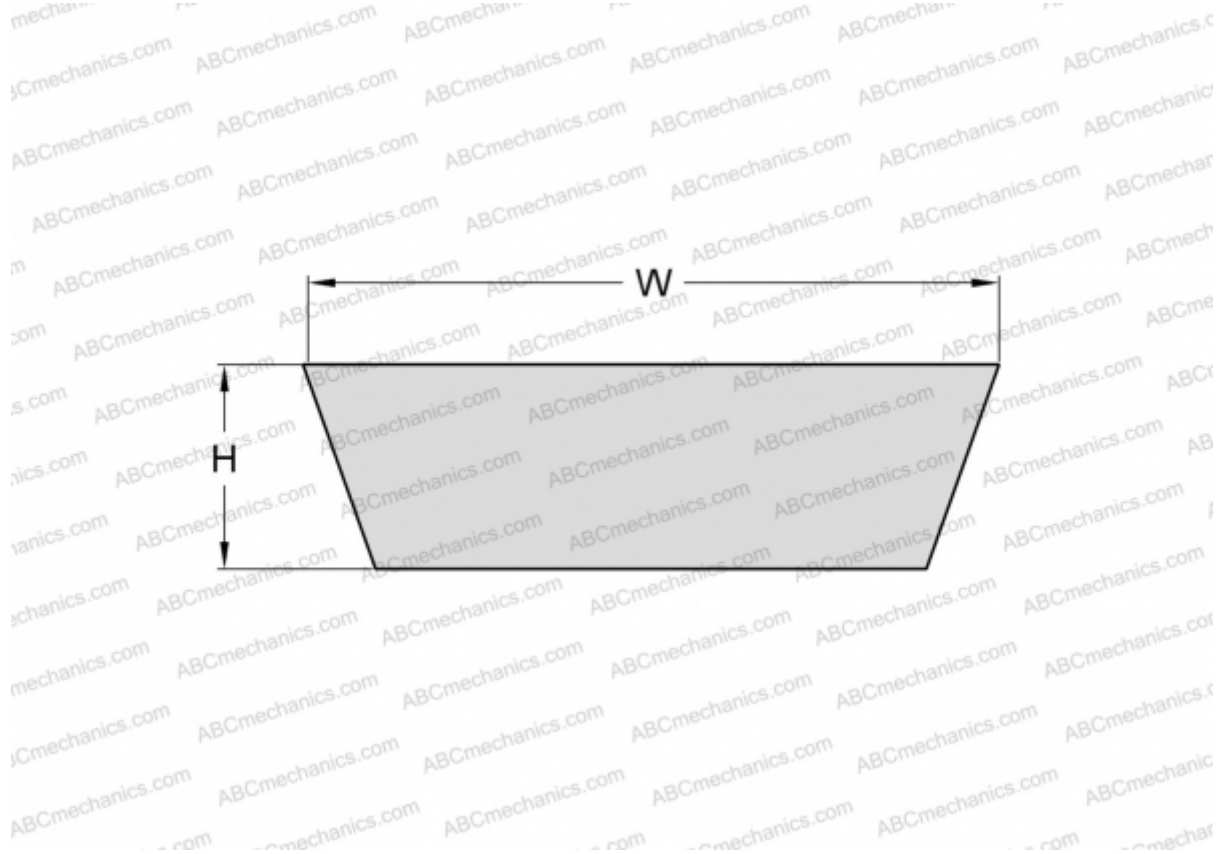

Technical specification

DIMENSIONS, MM

Estimated length	1653,000
Inner length	1600,000
Width, W	41,000
Height, H	13,000
Number of teeth	1

MANUFACTURER

[SKF](#)