

PHG VS47X13X1250 SKF

Variable speed belt

TYPE: V- belts, Variable speed belts, Section VS (SKF)

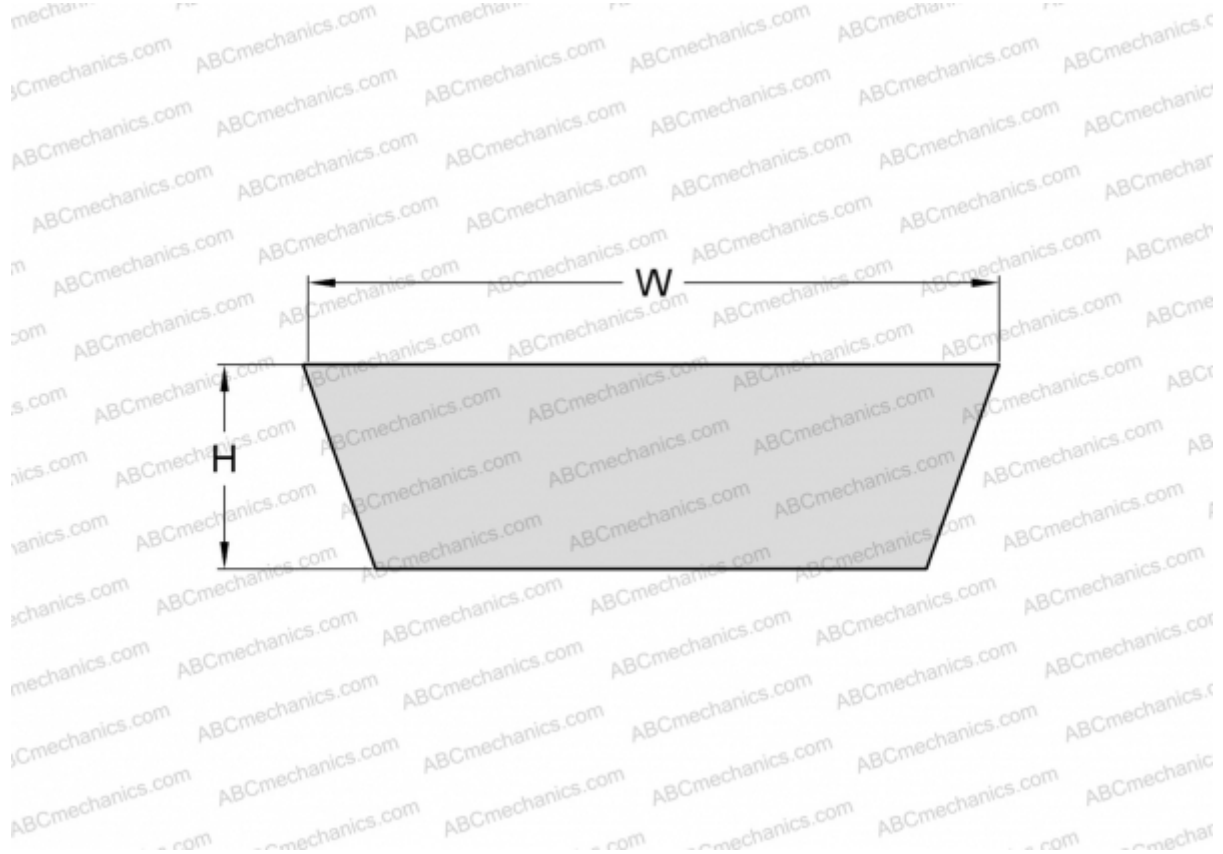

Technical specification

DIMENSIONS, MM

Estimated length	1303,000
Inner length	1250,000
Width, W	47,000
Height, H	13,000
Number of teeth	1

MANUFACTURER

[SKF](#)