

## PHG VS47X13X1800 SKF

Variable speed belt

TYPE: V- belts, Variable speed belts, Section VS (SKF)

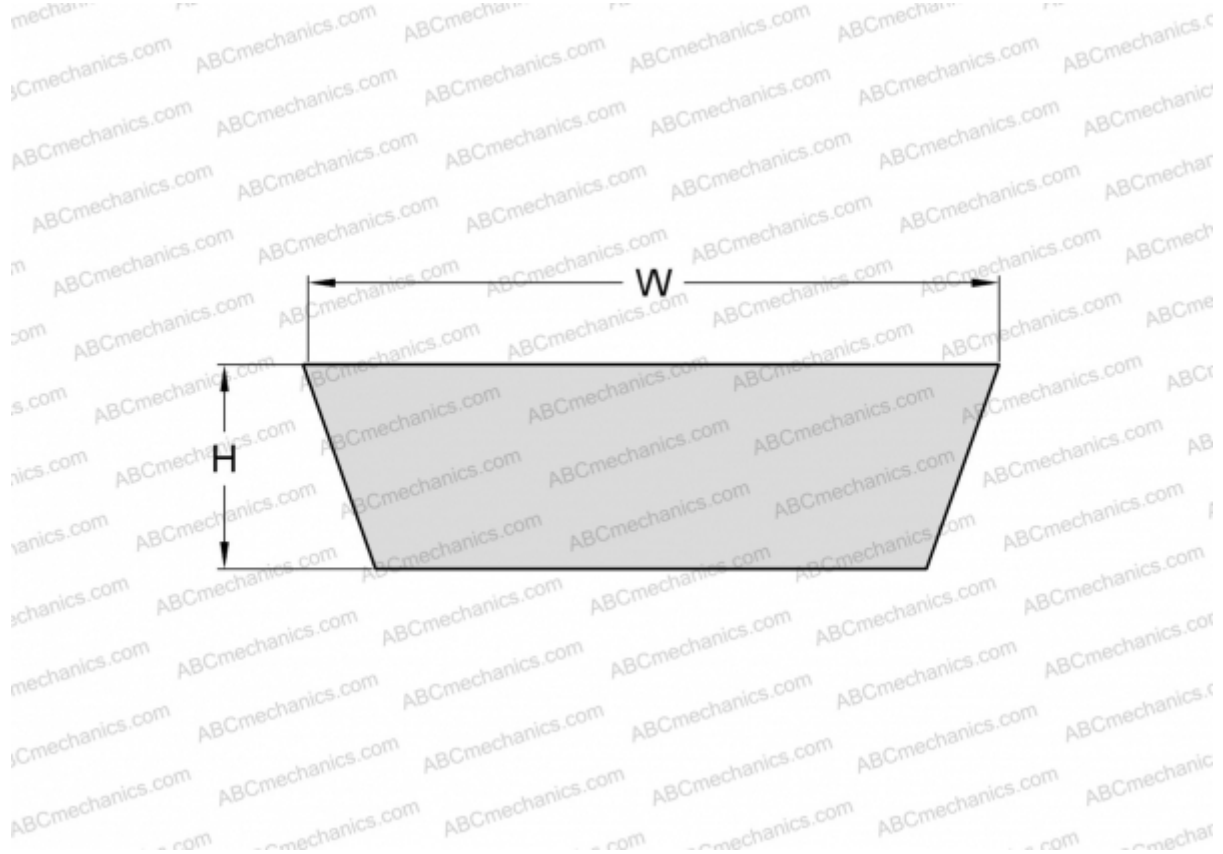

### Technical specification

#### DIMENSIONS, MM

Estimated length	1853,000
Inner length	1800,000
Width, W	47,000
Height, H	13,000
Number of teeth	1

#### MANUFACTURER

[SKF](#)