

PHG VS52X16X1925 SKF

Variable speed belt

TYPE: V- belts, Variable speed belts, Section VS (SKF)

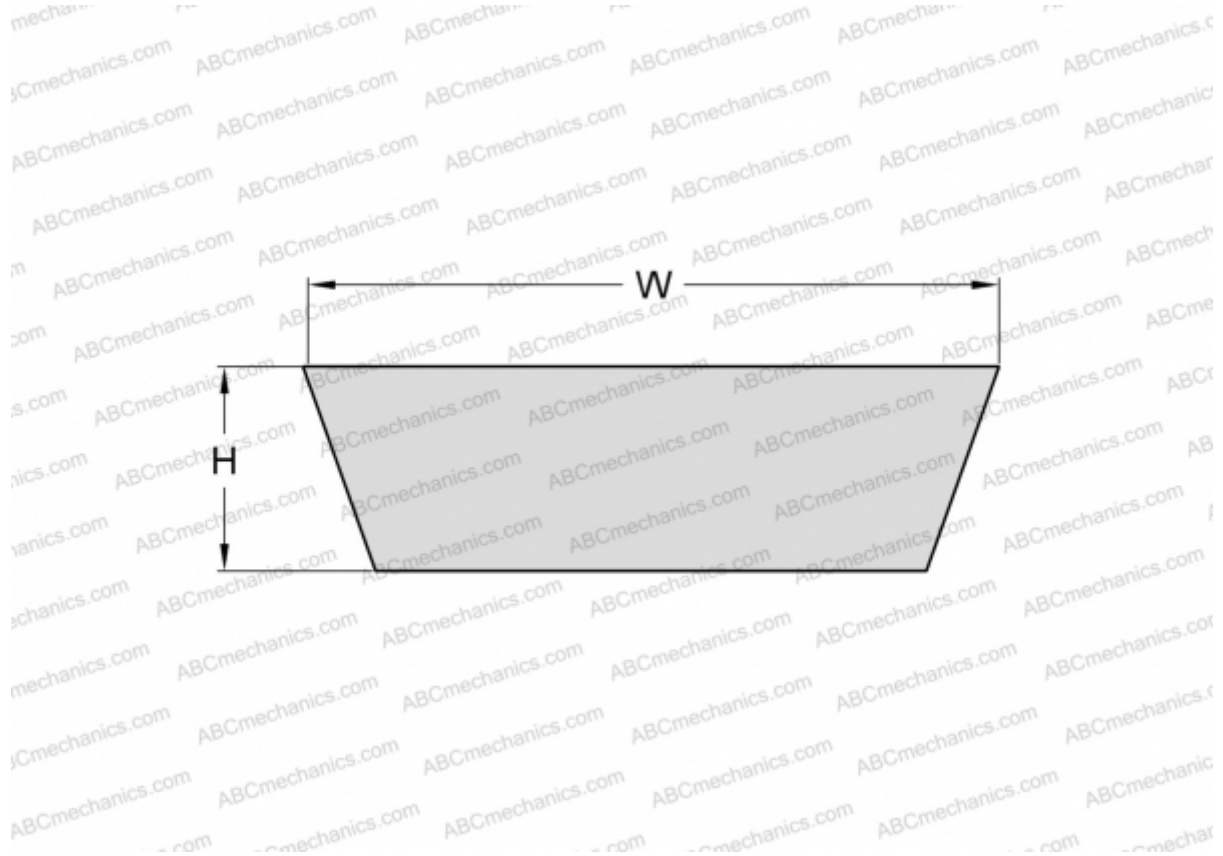

Technical specification

DIMENSIONS, MM

Estimated length	1978,000
Inner length	1925,000
Width, W	52,000
Height, H	16,000
Number of teeth	1

MANUFACTURER

[SKF](#)