

PHG VS65X20X1906 SKF

Variable speed belt

TYPE: V- belts, Variable speed belts, Section VS (SKF)

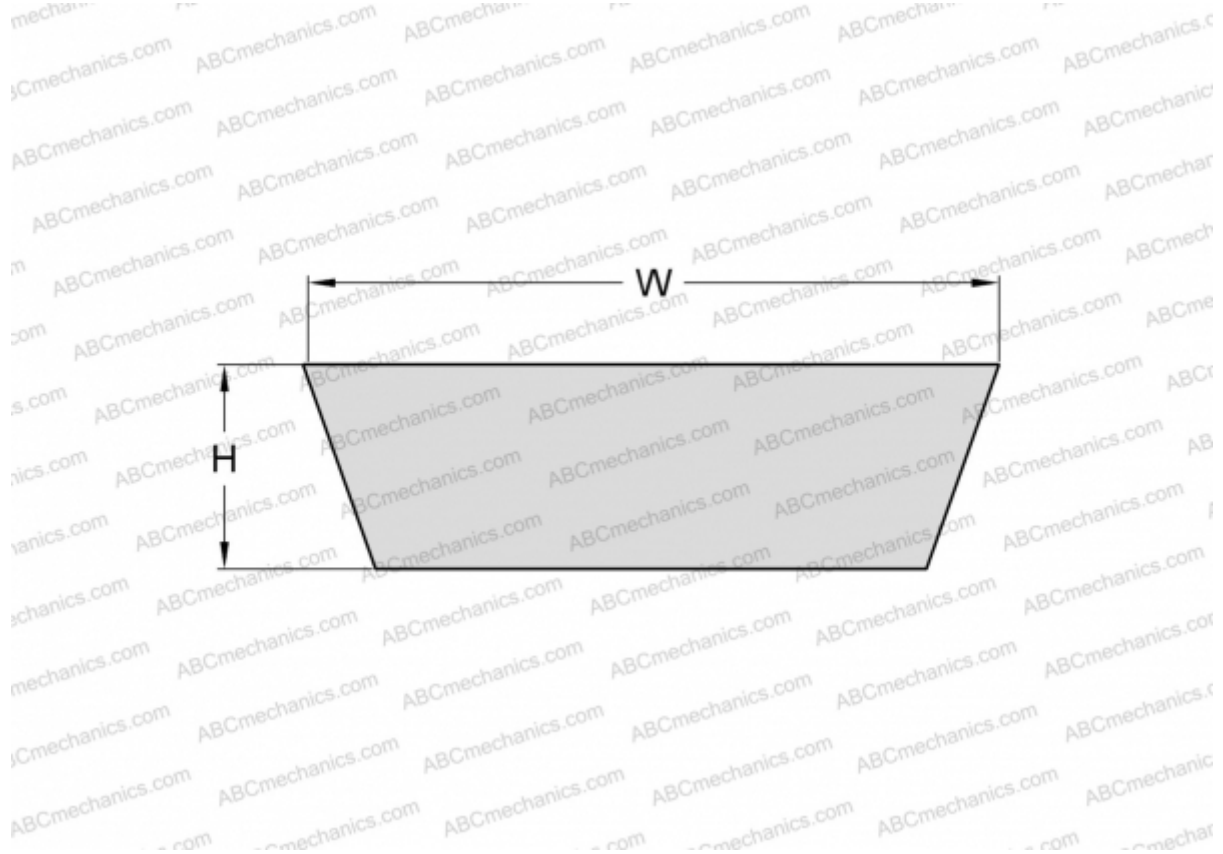

Technical specification

DIMENSIONS, MM

Estimated length	1972,000
Inner length	1906,000
Width, W	65,000
Height, H	20,000
Number of teeth	1

MANUFACTURER

[SKF](#)