

PHG VS70X18X1900 SKF

Variable speed belt

TYPE: V- belts, Variable speed belts, Section VS (SKF)

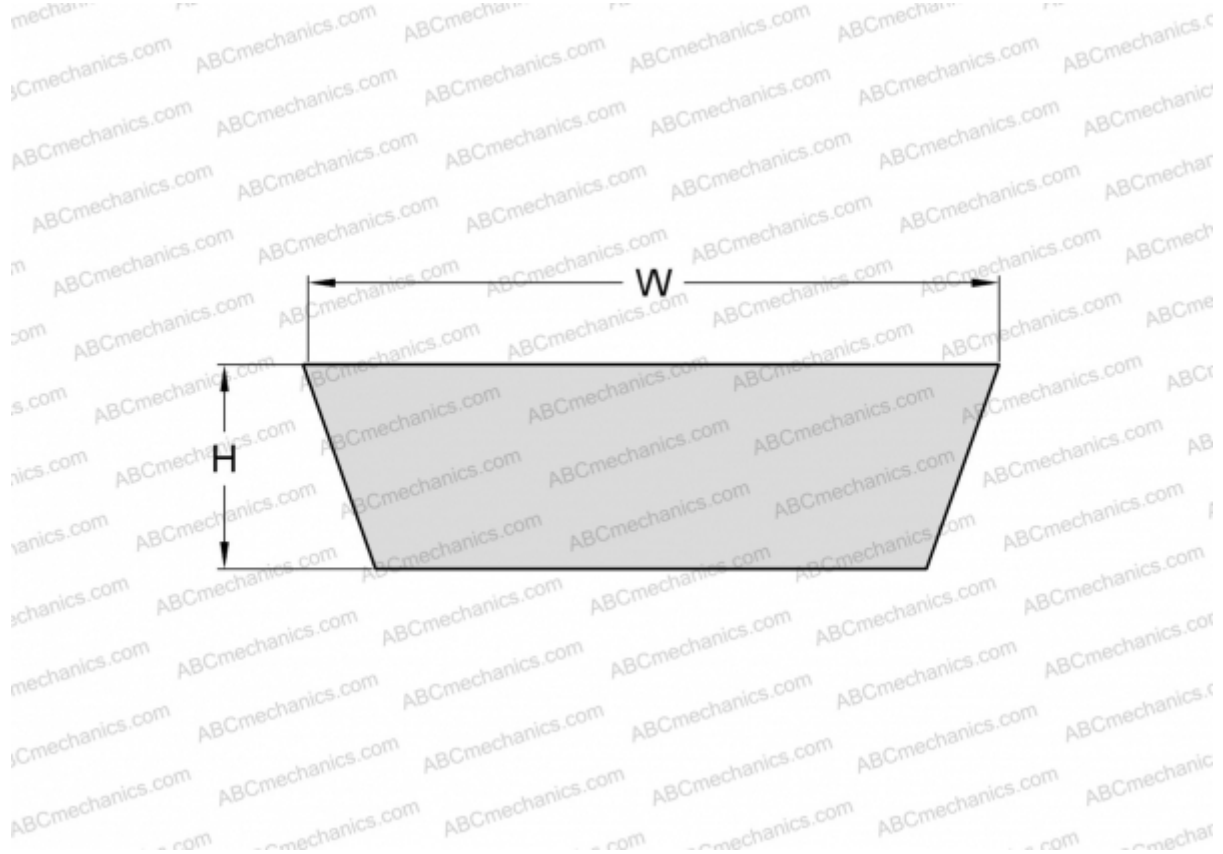

Technical specification

DIMENSIONS, MM

Estimated length	1966,000
Inner length	1900,000
Width, W	70,000
Height, H	18,000
Number of teeth	1

MANUFACTURER

[SKF](#)