

PHG A47X3 SKF

Banded classical belt

TYPE: V- belts, Banded belts, Classical, Section 13/A (SKF)

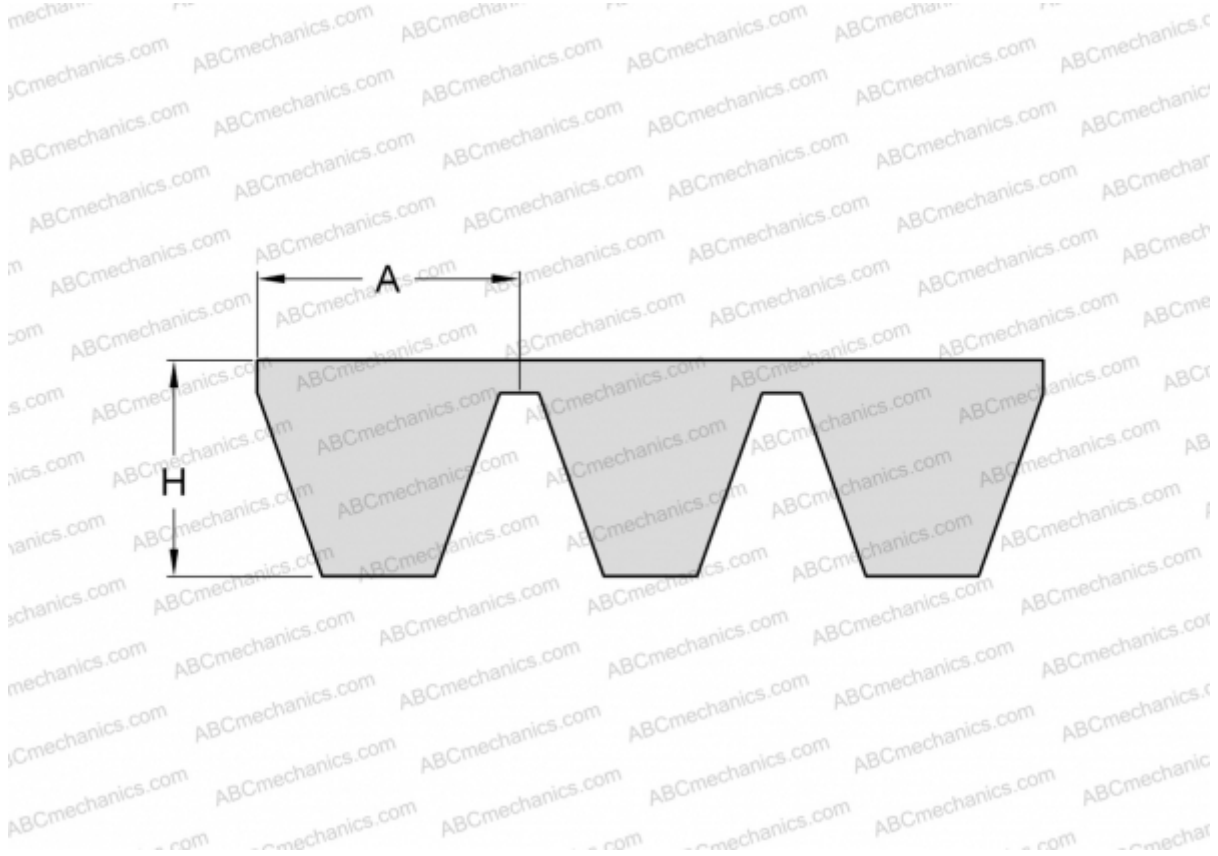

Technical specification

DIMENSIONS, MM

Estimated length	1230,000
Inner length	1193,800
Width, W	39,000
Height, H	9,900
A	13,000

MANUFACTURER

[SKF](#)