

## PHG A57X5 SKF

Banded classical belt

TYPE: V- belts, Banded belts, Classical, Section 13/A (SKF)

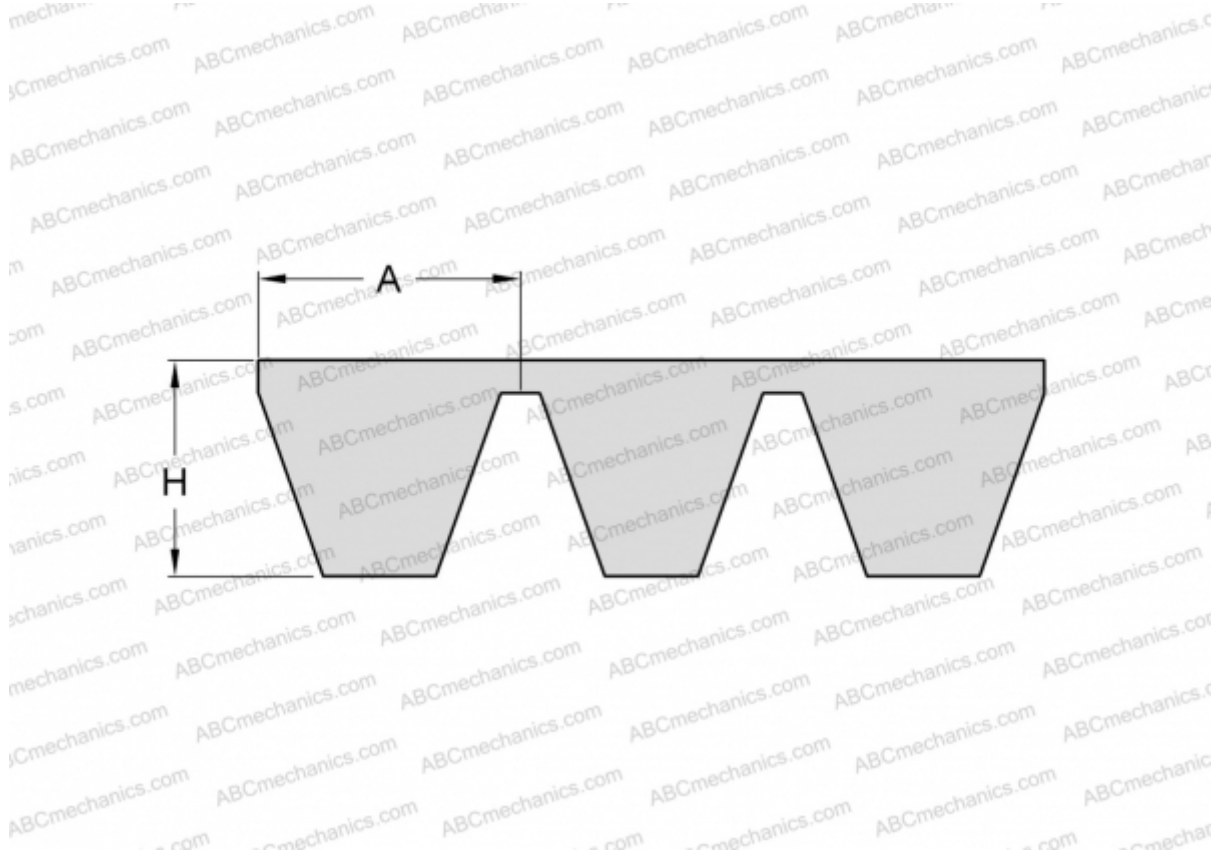

### Technical specification

#### DIMENSIONS, MM

Estimated length	1480,000
Inner length	1447,800
Width, W	65,000
Height, H	9,900
A	13,000

#### MANUFACTURER

[SKF](#)