

PHG A64X4 SKF

Banded classical belt

TYPE: V- belts, Banded belts, Classical, Section 13/A (SKF)

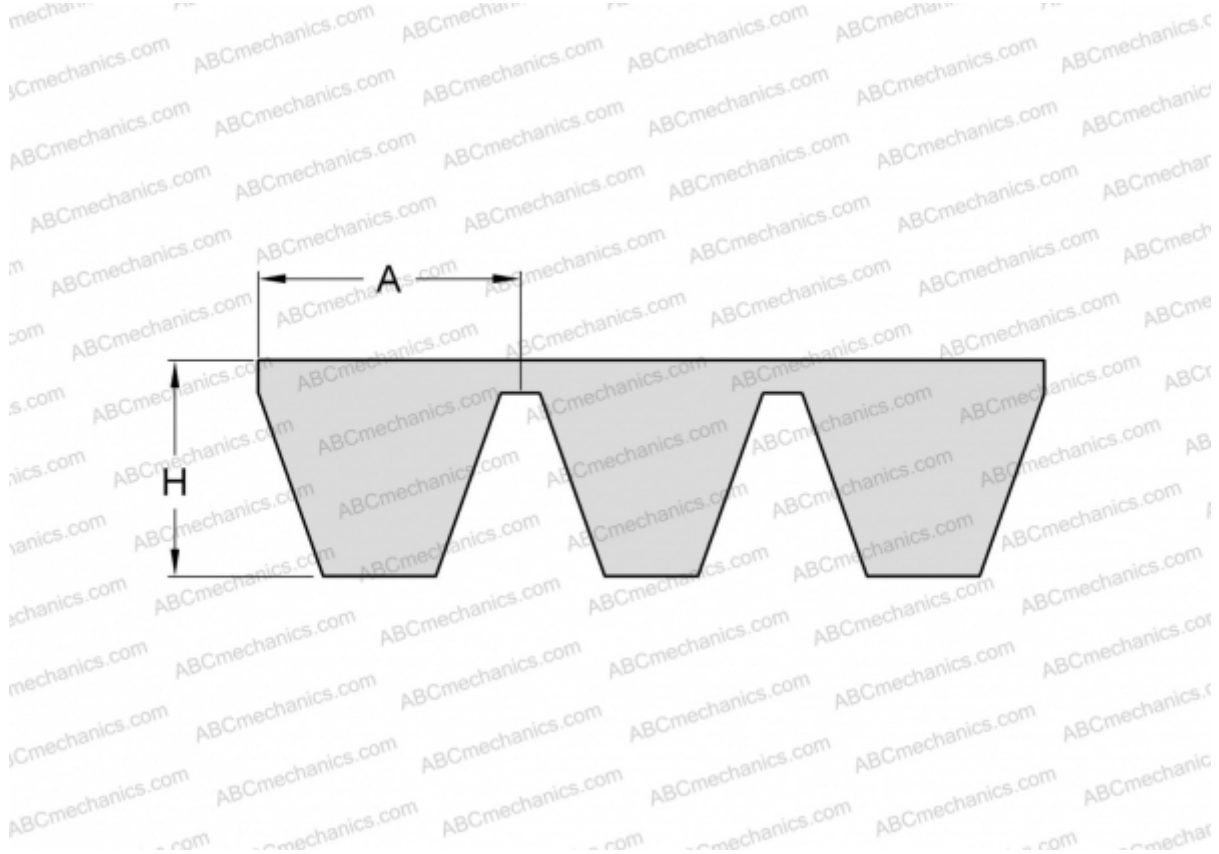

Technical specification

DIMENSIONS, MM

Estimated length	1660,000
Inner length	1625,600
Width, W	52,000
Height, H	9,900
A	13,000

MANUFACTURER

[SKF](#)