

## PHG A144X3 SKF

Banded classical belt

TYPE: V- belts, Banded belts, Classical, Section 13/A (SKF)

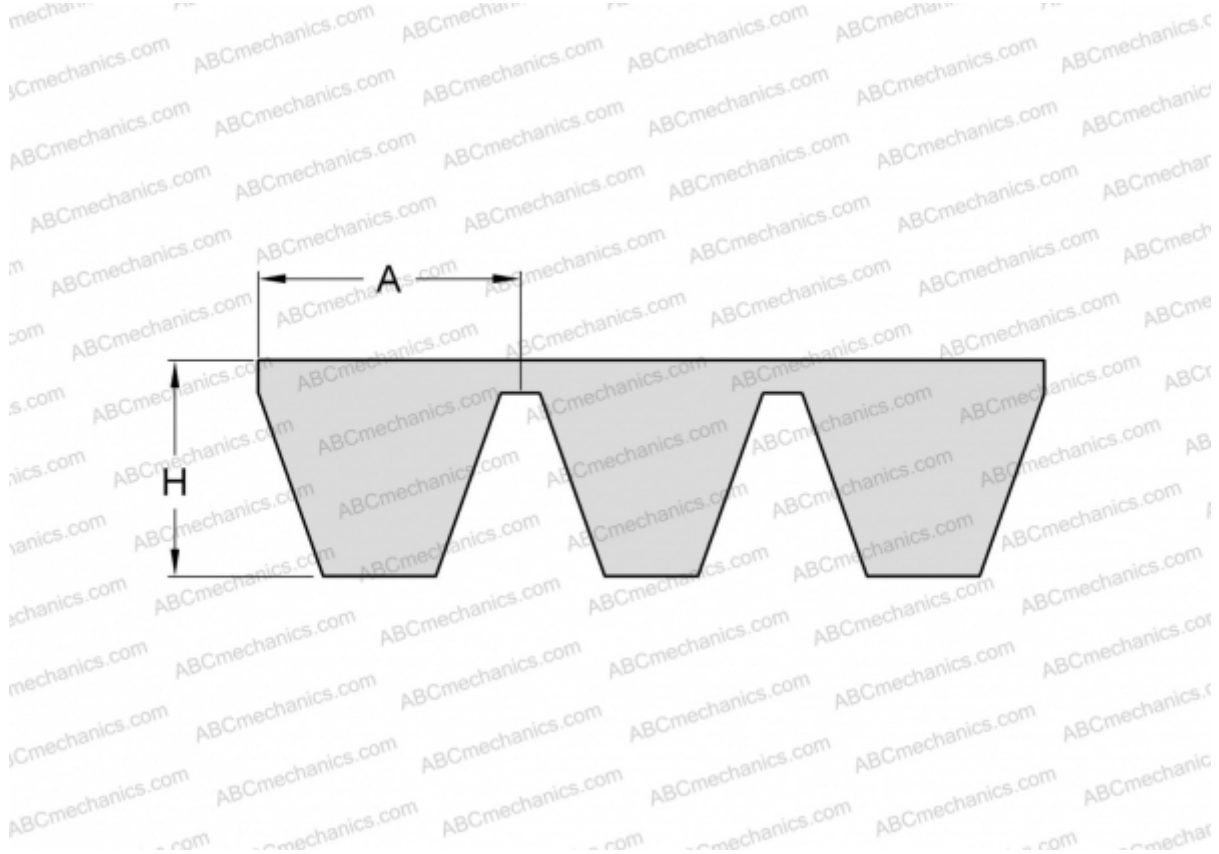

### Technical specification

#### DIMENSIONS, MM

Estimated length	3690,000
Inner length	3657,600
Width, W	39,000
Height, H	9,900
A	13,000

#### MANUFACTURER

[SKF](#)