

PHG B64X3 SKF

Banded classical belt

TYPE: V- belts, Banded belts, Classical, Section 17/B (SKF)

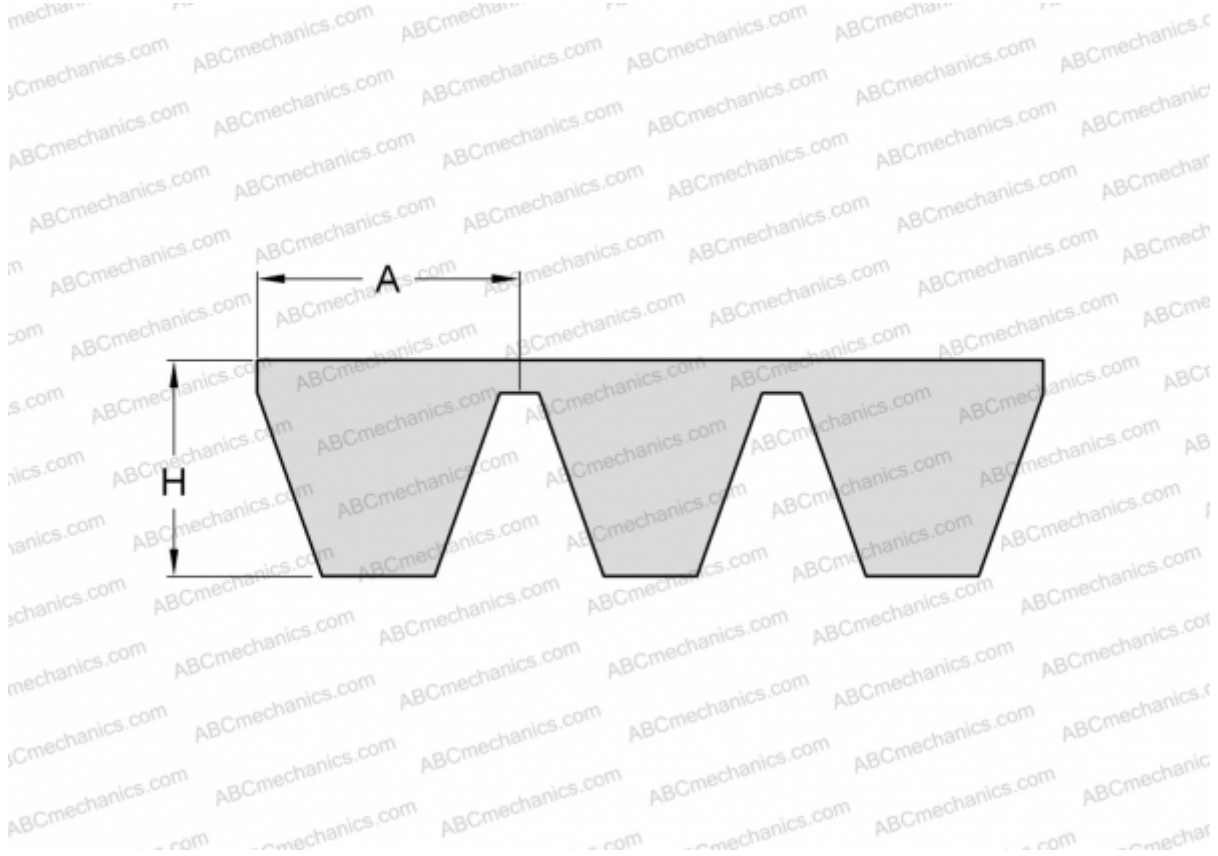

Technical specification

DIMENSIONS, MM

Estimated length	1670,000
Inner length	1625,600
Width, W	51,000
Height, H	13,000
A	17,000

MANUFACTURER

[SKF](#)