

PHG B64X5 SKF

Banded classical belt

TYPE: V- belts, Banded belts, Classical, Section 17/B (SKF)

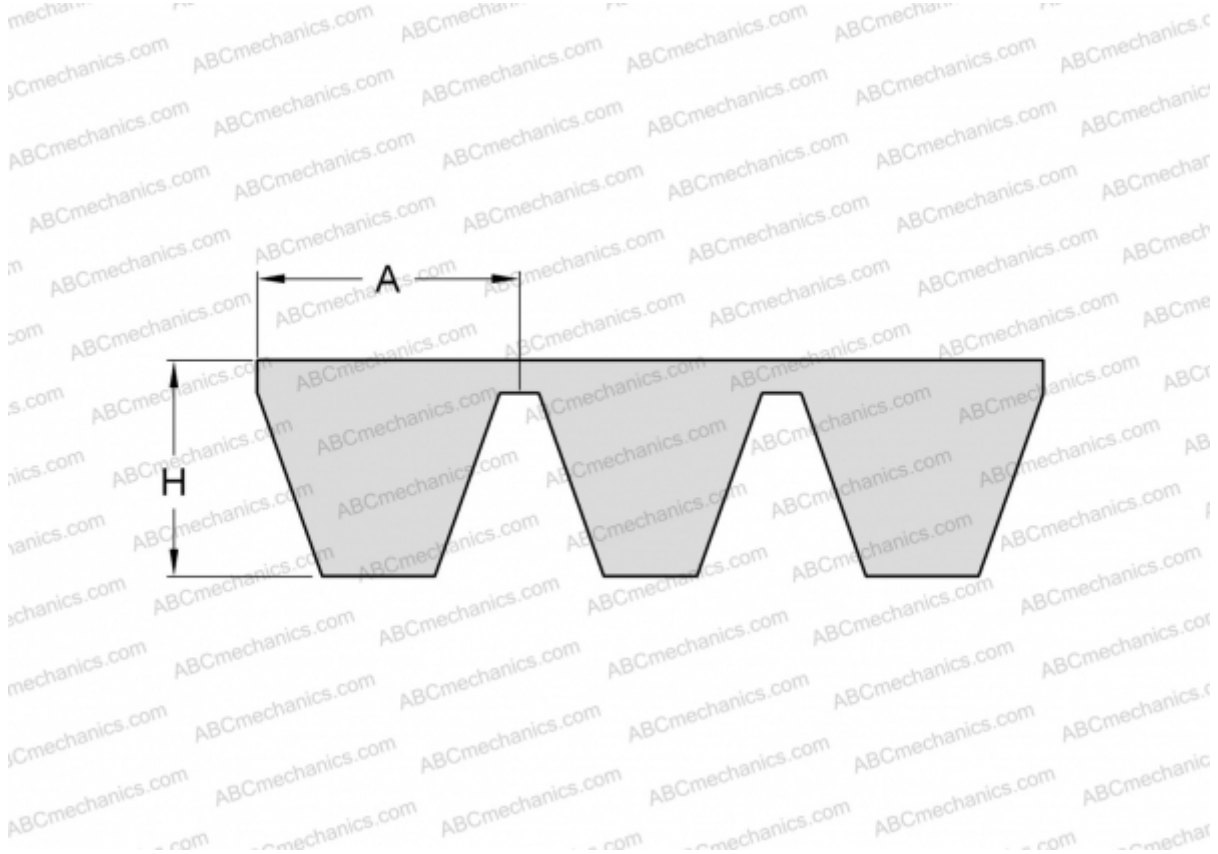

Technical specification

DIMENSIONS, MM

| | |
|------------------|----------|
| Estimated length | 1670,000 |
| Inner length | 1625,600 |
| Width, W | 85,000 |
| Height, H | 13,000 |
| A | 17,000 |

MANUFACTURER

[SKF](#)