

## PHG B71X3 SKF

Banded classical belt

TYPE: V- belts, Banded belts, Classical, Section 17/B (SKF)

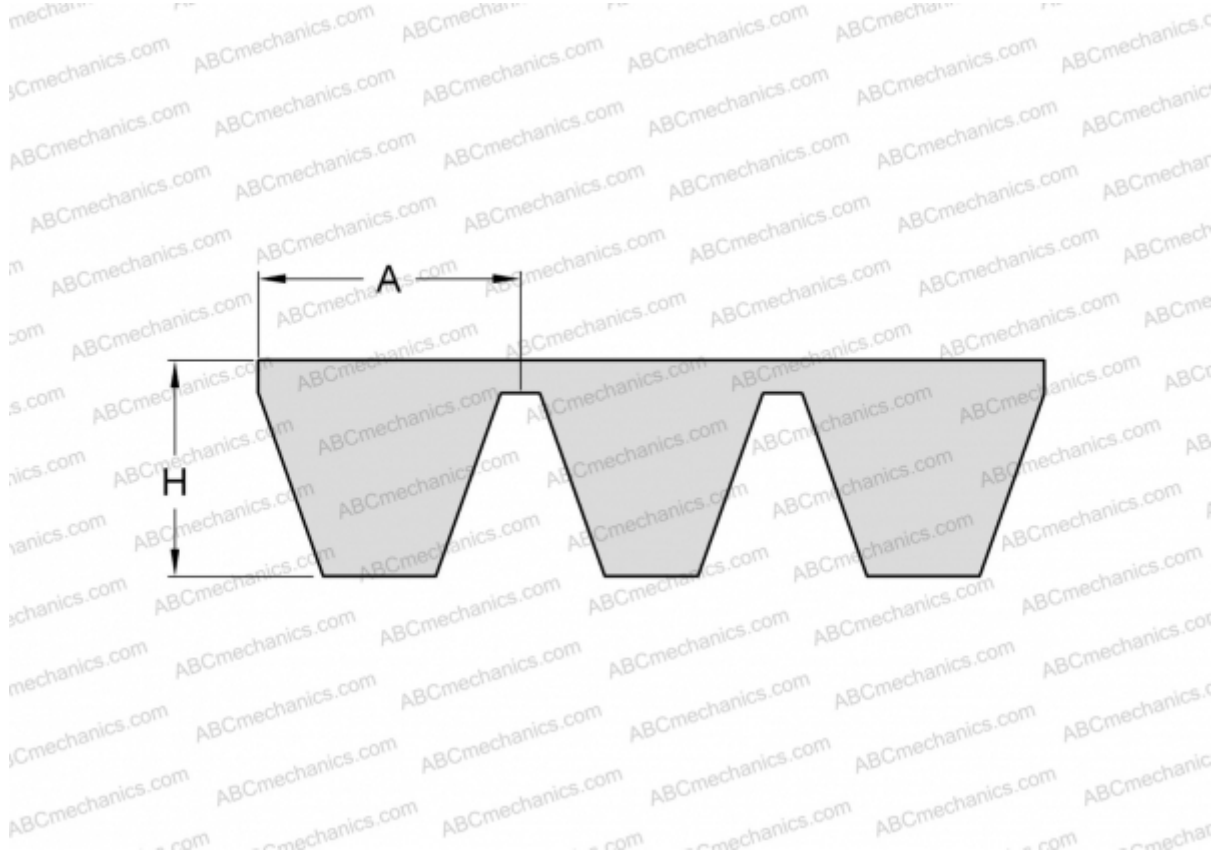

### Technical specification

#### DIMENSIONS, MM

Estimated length	1850,000
Inner length	1803,400
Width, W	51,000
Height, H	13,000
A	17,000

#### MANUFACTURER

[SKF](#)