

## PHG B118X3 SKF

Banded classical belt

TYPE: V- belts, Banded belts, Classical, Section 17/B (SKF)

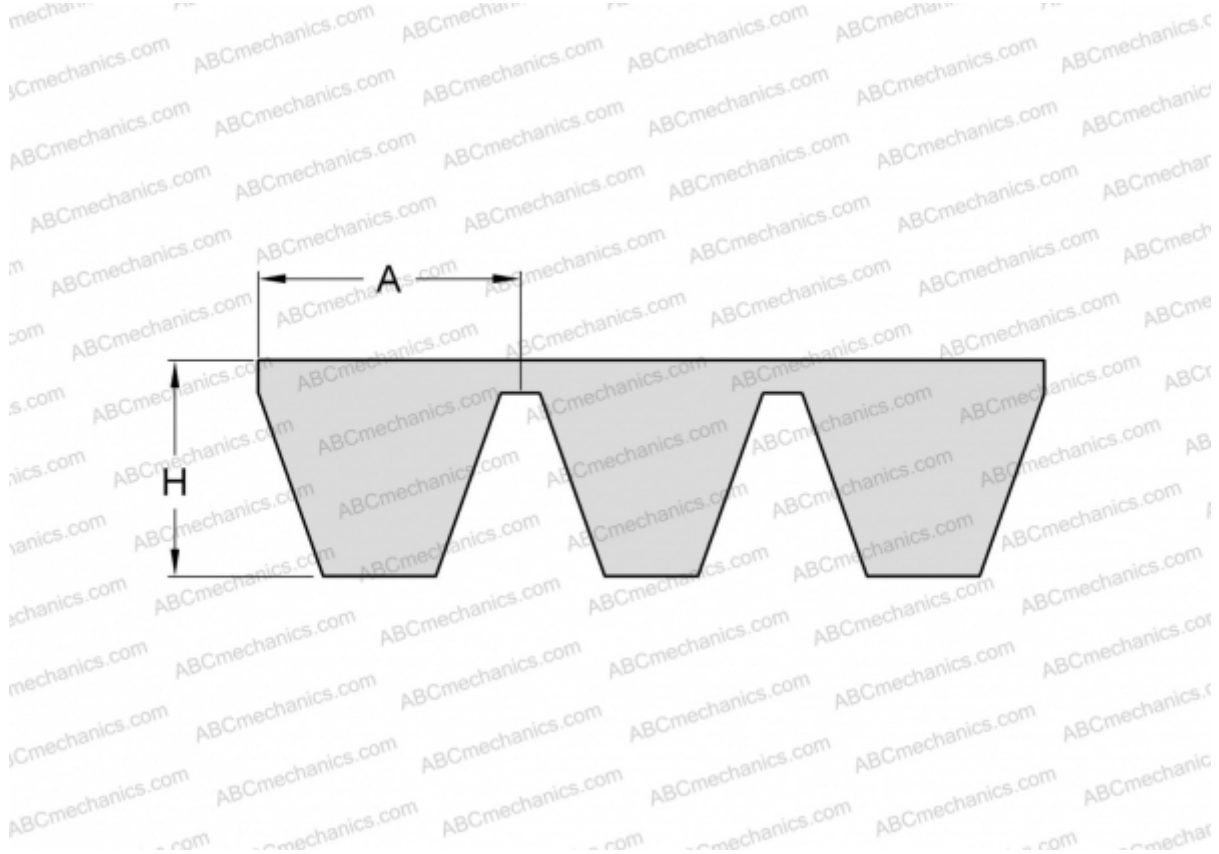

### Technical specification

#### DIMENSIONS, MM

Estimated length	3040,000
Inner length	2997,200
Width, W	51,000
Height, H	13,000
A	17,000

#### MANUFACTURER

[SKF](#)