

PHG B177X5 SKF

Banded classical belt

TYPE: V- belts, Banded belts, Classical, Section 17/B (SKF)

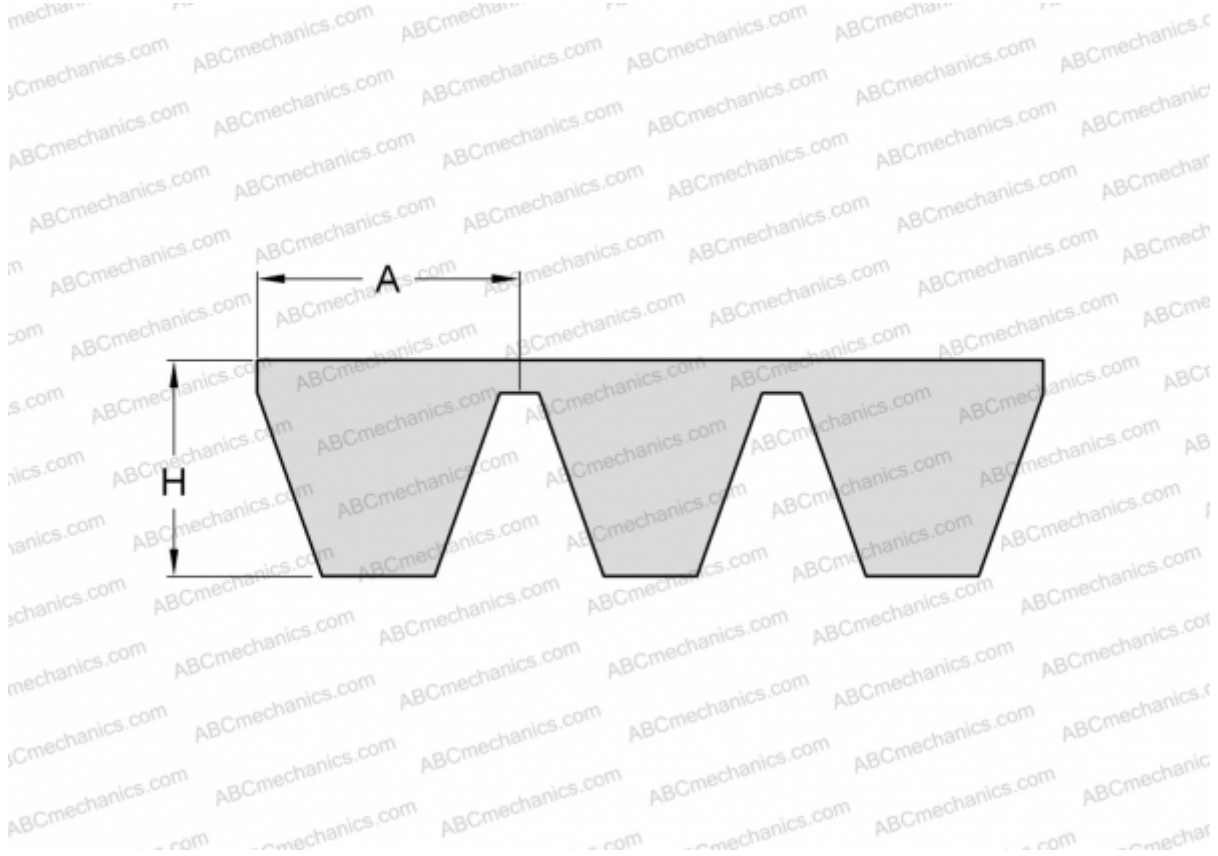

Technical specification

DIMENSIONS, MM

Estimated length	4540,000
Inner length	4495,800
Width, W	85,000
Height, H	13,000
A	17,000

MANUFACTURER

[SKF](#)