

PHG B187X4 SKF

Banded classical belt

TYPE: V- belts, Banded belts, Classical, Section 17/B (SKF)

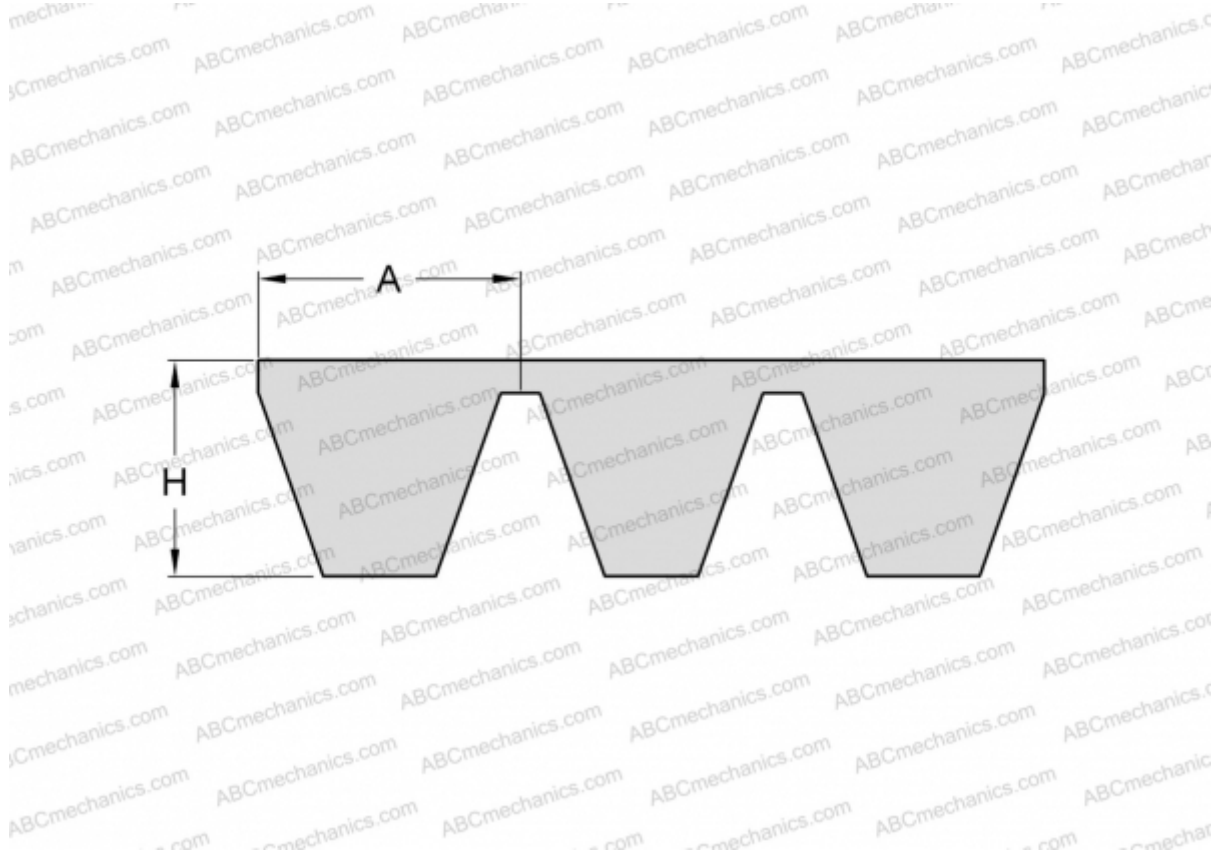

Technical specification

DIMENSIONS, MM

Estimated length	4800,000
Inner length	4749,800
Width, W	68,000
Height, H	13,000
A	17,000

MANUFACTURER

[SKF](#)