

## PHG B220X4 SKF

Banded classical belt

TYPE: V- belts, Banded belts, Classical, Section 17/B (SKF)

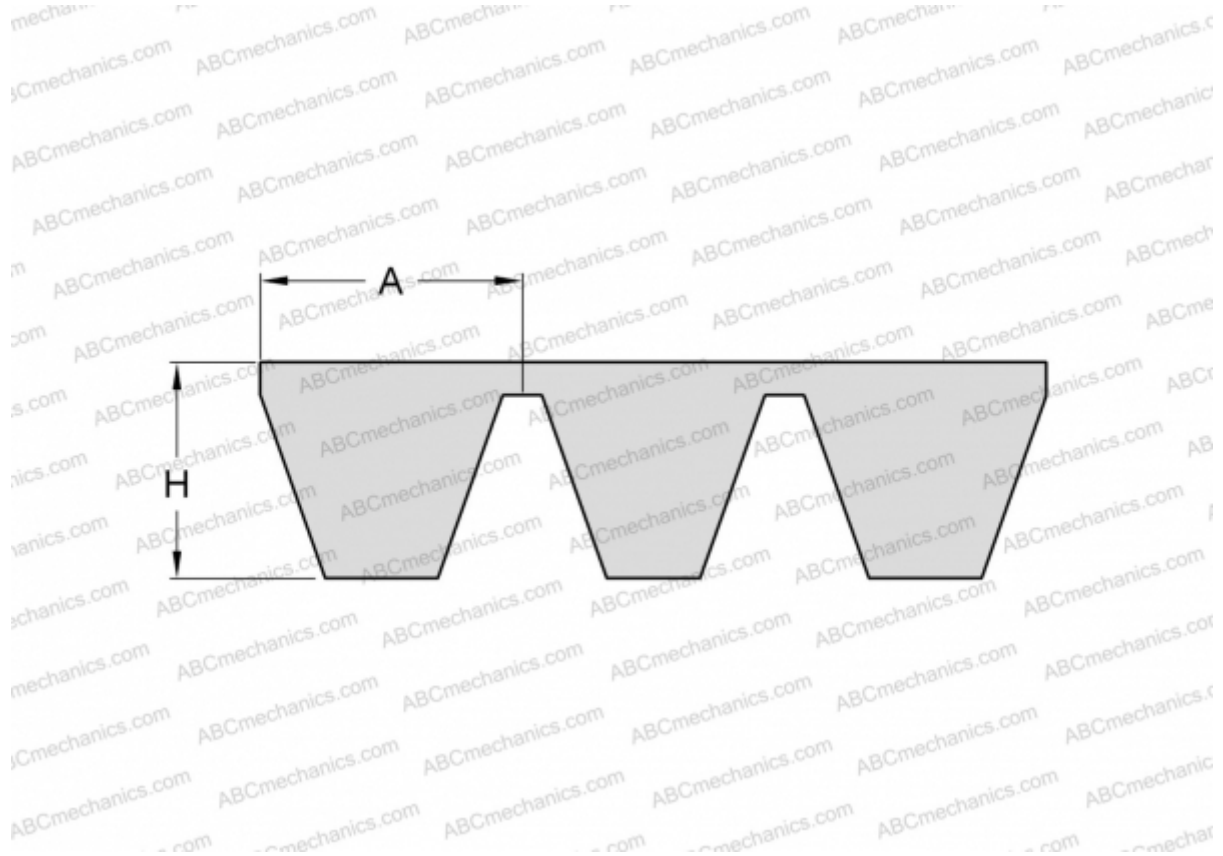

### Technical specification

#### DIMENSIONS, MM

Estimated length	5630,000
Inner length	5588,000
Width, W	68,000
Height, H	13,000
A	17,000

#### MANUFACTURER

[SKF](#)